

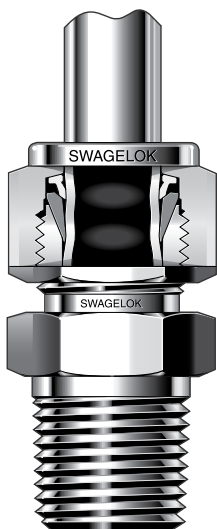

An Installer's
Pocket Guide
for Swagelok®

Tube Fittings



Swagelok®

Intermixing/Interchanging	8
Metric Swagelok Tube Fittings	8
Installation Instructions	
■ Safety Precautions	9
■ Up to 1 in./25 mm Swagelok Tube Fittings	10
■ Over 1 in./25 mm Swagelok Tube Fittings	11
■ Gaugeability	11
■ Reassembly	12
■ O-Seal Male Connectors	13
■ Caps and Plugs	13
■ Pipe Thread Fittings	13
■ Port Connectors	14
■ Positionable Elbows and Tees	16
■ Tube Adapters	16
■ Weld Fittings	17
■ Depth Marking Tool	17
■ Preswaging Tool	18
Hydraulic Swaging Units	
■ Multihead (MHSU)	19
■ Air-Actuated (AHSU)	20
Tubing	
■ Installation	21
■ Selection	22
■ Gas Service	22
■ Fractional Carbon Steel Tubing	23
■ Metric Carbon Steel Tubing	25
■ Fractional Stainless Steel Seamless Tubing .	27
■ Metric Stainless Steel Seamless Tubing	29
■ Fractional Copper Tubing	31
Ordering Information	32
Straight Fittings	
 Unions	
■ Union	33
■ Reducing Union	35

Straight Fittings

Unions

- Bulkhead Union 37
- Bulkhead Reducing Union 37

Male Connectors



- NPT 38
- ISO/BSP Tapered Thread (RT) 40
- ISO/BSP Parallel Thread (RS) 42
- ISO/BSP Parallel Thread (RP) 44
- Bulkhead NPT 46
- SAE/MS Straight Thread (ST) 47
- O-Seal (SAE/MS Straight Thread) 48
- O-Seal (NPT) 48
- AN Fitting 49
- AN Bulkhead Fitting 49
- 10-32 Thread 50
- M5 × 0.8 Thread 50
- Metric Thread (RS) 50

Weld Connectors



- Tube Socket Weld 51
- Male Pipe Weld 51

Female Connectors



- NPT 53
- ISO/BSP Tapered Thread (RT) 55
- ISO/BSP Parallel Thread (RJ) 56
- ISO/BSP Parallel Thread (RP) 56
- ISO/BSP Parallel Thread (RG, Gauge) 57
- Bulkhead NPT 58

Reducers



- Reducer 59
- Long Reducer 62
- Bulkhead Reducer 62

Port Connectors



- Port Connector 63
- Reducing Port Connector 64

Straight Fittings



Caps and Plugs

- Cap 65
- Plug 66
- **Vent Protectors** 67

90° Elbows



Unions

- Union 68



Male

- NPT 69
- ISO/BSP Tapered Thread (RT) 71
- Reducing 73
- Positionable, SAE/MS
Straight Thread (ST) 73
- Positionable, ISO/BSP
Parallel Thread (PR) 74



Weld

- Tube Socket Weld 75
- Male Pipe Weld 75



Female

- NPT 76

45° Elbows



Male

- NPT 77
- Positionable, SAE/MS
Straight Thread (ST) 77

Tees



Unions

- Union 78
- Reducing Union 79



Male

- Branch, NPT (TTM) 81
- Run, NPT (TMT) 82
- Positionable Branch, SAE/MS
Straight Thread (TTS) 83

Tees

Male

- Positionable Run, SAE/MS
Straight Thread (TST) 83
- Positionable Branch, ISO/BSP
Parallel Thread (TTR) 84
- Positionable Run, ISO/BSP
Parallel Thread (TRT) 85



Female

- Run, NPT (TFT) 86
- Branch, NPT (TTF) 87



Cross, Union 88



Sanitary Flange Fittings 89

Tube Adapters

Male



- NPT 90
- ISO/BSP Tapered Thread (RT) 91
- ISO/BSP Parallel Thread (RS) 92
- ISO/BSP Parallel Thread (RP) 93
- SAE/MS Straight Thread (ST) 94
- O-Seal (SAE/MS Straight Thread) . 94
- AN Thread 94
- Pipe Weld 94

Female



- NPT 95
- ISO/BSP Tapered Thread (RT) 96
- ISO/BSP Parallel Thread (RP) 96
- ISO/BSP Parallel Thread
(RG, Gauge) 97
- ISO/BSP Parallel Thread (RJ) 98
- AN Thread 98

Part Numbering

- Tube Fitting Part Numbers 99
- Tube Adapter Part Numbers 102

Replacement Parts



Nuts

- Female 104
- Knurled Female 105
- Male 105



Ferrules

- Front 106
- Back 107
- Nut-Ferrule Sets, Packages 108
- Ferrule Sets, Ferrule-Paks™ 109



ISO/BSP Parallel Gaskets

- Steel and Stainless Steel
(RS Fitting) 110
- Copper
(RP and RS Fitting) 111
- Copper and Nickel
(RG, Gauge Fitting) 111
- PTFE (RJ Fitting) 111



O-Rings

- Buna N (O-Seal
Straight Threads) 112
- Buna N (O-Seal Pipe Threads) 112
- Fluorocarbon FKM
(Positionable Fittings,
ISO/BSP Parallel Threads) 113
- Fluorocarbon FKM
(SAE/MS Straight Threads) 113

Tools and Accessories



- Bulkhead Retainers** 114



- Gap Inspection Gauges** 115

- Depth Marking Tools** 117



- Preswaging Tools** 118



- Inserts for Soft Plastic Tubing** 119

Intermix/Interchange with Other Manufacturers' Components

This practice can be dangerous. Leak-tight seals that will withstand high pressure, vibration, vacuum, and temperature changes depend on close tolerances and consistent, exacting quality control in conjunction with good design principles. The critical interaction of precision parts is essential for reliability and safety.

Components of other manufacturers may look like Swagelok tube fitting components—but they cannot be manufactured in accordance with Swagelok engineering standards, nor do they benefit from innovations in design and manufacture defined by 36 active Swagelok tube fitting patents issued since 1989.

Metric Swagelok Tube Fittings

Metric tube fittings have a stepped shoulder on the body hex.

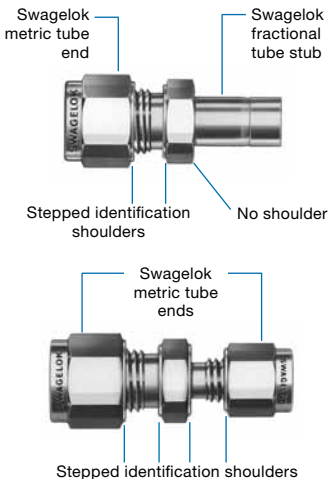

Shaped fittings, such as elbows, crosses, and tees, are stamped MM for metric tubing and have no step on the forging.

Installation Instructions

Swagelok tube fittings 1 in./25 mm and smaller can be installed quickly, easily, and reliably with simple hand tools.

Over 1 in./25 mm sizes require use of a hydraulic swaging unit to swage the ferrules onto the tubing.

Safety Precautions

- Do not bleed system by loosening fitting nut or fitting plug.
- Do not assemble and tighten fittings when system is pressurized.
- Make sure that the tubing rests firmly on the shoulder of the tube fitting body before tightening the nut.
- Use the correct Swagelok gap inspection gauge to ensure sufficient pull-up upon initial installation.
- Always use proper thread sealants on tapered pipe threads.
- Do not mix materials or fitting components from various manufacturers—tubing, ferrules, nuts, and fitting bodies.
- Never turn fitting body. Instead, hold fitting body and turn nut.
- Avoid unnecessary disassembly of unused fittings.
- Use only long reducers in female Swagelok end connections.

See the instructions starting below for installation of Swagelok tube fittings, O-seal male connectors, caps and plugs, port connectors, tube adapters, positionable elbows and tees, weld fittings, depth marking tool, and preswaging tool.

Swagelok Tube Fittings

Up to 1 in./25 mm

These instructions apply both to traditional fittings and to fittings with the advanced back-ferrule geometry.

Fully insert the tube into the fitting and against the shoulder; rotate the nut finger-tight.

High-pressure applications and high safety-factor systems:

Further tighten the nut until the tube will not turn by hand or move axially in the fitting.

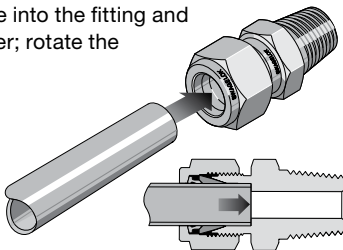

Mark the nut at the 6 o'clock position.

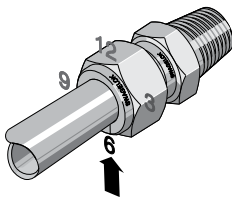

While holding the fitting body steady, tighten the nut one and one-quarter turns to the 9 o'clock position.

For 1/16, 1/8, and 3/16 in.; 2, 3, and 4 mm tube fittings, tighten the nut three-quarters turn to the 3 o'clock position.

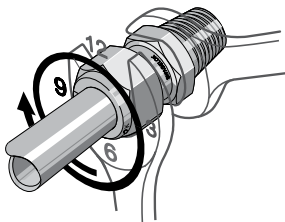

Swagelok Tube Fittings

Over 1 in./25 mm

1. Preswage the ferrules onto the tube using a Swagelok multihead hydraulic swaging unit (MHSU).
2. Apply the lubricant packaged with the fitting lightly to the body threads and the rear surface of the back ferrule.
3. Insert the tube with preswaged ferrules into the fitting until the front ferrule seats against the fitting body; rotate the nut finger-tight.
4. Mark the nut at the 6 o'clock position.
5. While holding the fitting body steady, tighten the nut one-half turn to the 12 o'clock position.

Use the Swagelok MHSU gap inspection gauge to ensure that the fitting has been tightened sufficiently.

Gaugeability

On initial installation, the Swagelok gap inspection gauge assures the installer or inspector that a fitting has been sufficiently tightened.

Position the Swagelok gap inspection gauge next to the gap between the nut and body.

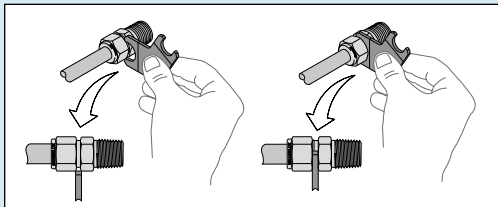

If the gauge **will not** enter the gap, **the fitting is sufficiently tightened.**

If the gauge **will** enter the gap, **additional tightening is required.**

⚠ Always depressurize a system before adjusting the tightness of a tube fitting connection.

Swagelok Tube Fittings

Reassembly—All Sizes

You may disassemble and reassemble Swagelok tube fittings many times.

⚠ Always depressurize the system before disassembling a Swagelok tube fitting.

Prior to disassembly, mark the tube at the back of the nut; mark a line along the nut and fitting body flats.

Use these marks to ensure that you return the nut to the previously pulled-up position.

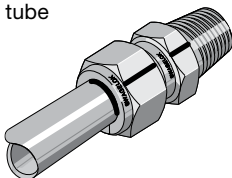

Insert the tube with preswaged ferrules into the fitting until the front ferrule seats against the fitting body.

Over 1 in./25 mm sizes:

If needed, reapply lubricant lightly to the body threads and the rear surface of the back ferrule.

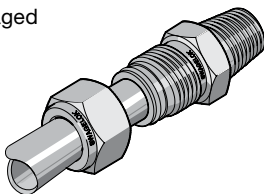

While holding the fitting body steady, rotate the nut with a wrench to the previously pulled-up position, as indicated by the marks on the tube and flats. At this point, you will feel a significant increase in resistance. Tighten the nut slightly.

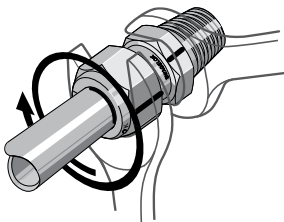

⚠ Do not use the Swagelok gap inspection gauge with reassembled fittings.

O-Seal Male Connectors

1. Turn the O-seal connector into the female end until it is finger-tight.
2. Tighten the O-seal connector until it makes metal-to-metal contact with the face of the female end.
3. Tighten slightly with a wrench.

O-rings are coated with a thin film of silicone-based lubricant. Removal of factory-applied lubricants may alter performance.

Caps and Plugs



Caps

See Swagelok tube fitting installation and reassembly, page 10 and 12.



Plugs

While holding fitting body steady, tighten the plug one-quarter turn from the finger-tight position.

For 1/16, 1/8, and 3/16 in.; 2, 3, and 4 mm tube fittings, tighten the plug one-eighth turn.

For over 1 in. and over 25 mm tube fittings, tighten the plug one-quarter turn.

⚠ Do not use the Swagelok gap inspection gauge with plug assemblies.

Reassembly

You may disassemble and reassemble Swagelok plugs many times. Make subsequent connections by slightly tightening with a wrench after snugging the nut by hand.

Pipe Thread Fittings

A thread sealant should always be used when assembling tapered threads. SWAK™ anaerobic pipe thread sealant, PTFE-Free pipe thread sealant, and Swagelok PTFE Tape are available. For more information, see the Swagelok *Leak Detectors, Lubricants, and Sealants* catalog, MS-01-91.

Port Connectors

Connect the machined ferrule end **before** connecting the tube adapter end.

Machined Ferrule End

1. Remove the nut and ferrules from the Swagelok end connection. Discard the ferrules.

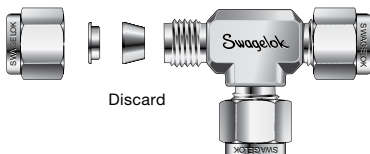

2. Slip the nut over the machined ferrule end of the port connector.

Over 1 in./25 mm sizes:

The nut is preassembled on the port connector.

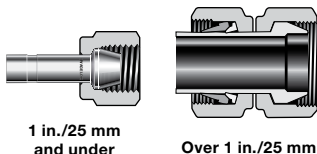

3. Insert the port connector into the end connection and finger-tighten the nut.

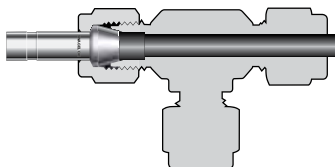

4. While holding fitting body steady, tighten the nut one-quarter turn.

For 1/16, 1/8, and 3/16 in.; 2, 3, and 4 mm tube fittings, tighten the nut one-eighth turn.

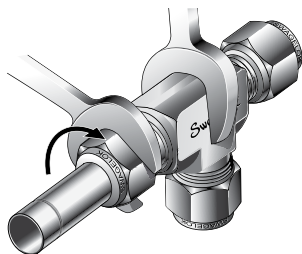

⚠ Do not use the Swagelok gap inspection gauge with machined ferrule ends.

Port Connectors

Reassembly

You may disassemble and reassemble Swagelok port connectors many times. Make subsequent connections by slightly tightening with a wrench after snugging the nut by hand.

Tube Adapter End

5. Insert the tube adapter until it rests firmly on the shoulder of the Swagelok tube fitting body. Finger-tighten the nut.

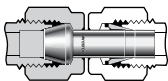

Over 1 in./25 mm sizes: Remove and discard the nut and ferrules from the end connection, then insert the tube adapter.

6. Mark the nut at the 6 o'clock position. While holding fitting body steady, tighten the nut one and one-quarter turns to the 9 o'clock position.

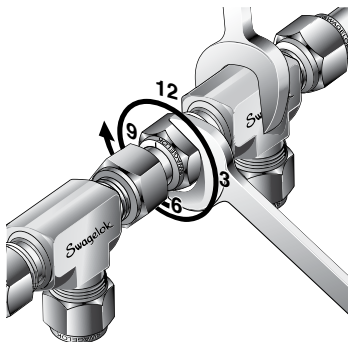

For 1/16, 1/8, and 3/16 in.; 2, 3, and 4 mm tube fittings, tighten the nut three-quarters turn to the 3 o'clock position.

For preswaged over 1 in./25 mm and over tube fittings, tighten the nut one-half turn to the 12 o'clock position.

⚠ Do not use the Swagelok gap inspection gauge with preswaged tube adapter connections over 1 in./25 mm.

Reassembly

See Swagelok tube fitting reassembly, page 12.

Positionable Elbows and Tees

1. Turn the positionable end into the female fitting until the metal backup washer contacts the face of the fitting.
2. Turn the positionable end out of the female fitting (not more than one turn) until the Swagelok tube fitting end is positioned properly.
3. While holding fitting body steady, tighten the lock nut until the metal backup washer contacts the face of the fitting.

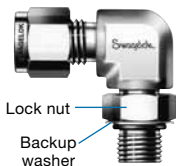

Tube Adapters

Up to 1 in./25 mm

1. Install the end opposite the tube adapter end (Fig. 1).
2. Insert the tube adapter into the Swagelok tube fitting. Make sure that the tube adapter rests firmly on the shoulder of the tube fitting body and that the nut is finger-tight (Fig. 2).
3. Mark the nut at the 6 o'clock position.
4. While holding fitting body steady, tighten the nut one and one-quarter turns to the 9 o'clock position.
For 1/16, 1/8, and 3/16 in.; 2, 3, and 4 mm tube fittings, tighten the nut three-quarters turn to the 3 o'clock position.

Fig. 1

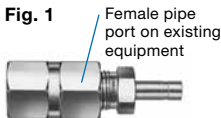

Fig. 2



Over 1 in./25 mm

Swagelok tube adapters over 1 in./25 mm are furnished with nuts and preswaged ferrules.

To assemble, follow steps 2 through 5 of the Swagelok tube fittings over 1 in./25 mm assembly instructions, page 11.

⚠ Do not use the Swagelok gap inspection gauge with preswaged tube adapter connections over 1 in./25 mm.

Tube Adapters

Reassembly

See Swagelok tube fitting reassembly, page 12.

Weld Fittings

Welding Precautions for Swagelok Tube Fittings with Weld End Connections

1. Remove the nut and ferrules.
2. Turn a Swagelok tube fitting plug or another nut onto the fitting so that it is finger-tight. This protects the threads and sealing components.
3. Provide a suitable heat sink to dissipate the heat.
4. Tack weld at four positions 90° apart to hold the fitting in place and to ensure alignment and concentricity of the components.
5. Complete the weld.
6. Remove the plug or nut and replace the nut and ferrules.

⚠ Caution: When welding carbon steel fittings, the heat often removes the protective oil from the threads. It is important to apply another lubricant, such as Goop™ thread lubricant.

Depth Marking Tool

1. Insert cleanly cut, fully deburred tube into the depth marking tool (DMT) until the tube is against the shoulder of the tool. Using a pen or pencil, mark the tube at the top of the DMT (Fig. 1).

Fig. 1



Fig. 2



2. Remove the tube from the DMT and insert it into the Swagelok fitting until it is against the shoulder of the fitting body (Fig. 2). Rotate the nut finger-tight. If any portion of the mark on the tube can be seen above the fitting nut, the tube is not fully inserted into the fitting.
3. While holding the fitting body steady, follow Swagelok tube fitting installation instructions, page 10.

Preswaging Tool

1. Install the Swagelok nut and ferrules onto the preswaging tool.
2. Insert the tube into the preswaging tool.
3. Make sure that the tube rests firmly on the shoulder of the preswaging tool body and that the nut is finger-tight.
4. Mark the nut at the 6 o'clock position.
5. While holding the preswaging tool steady, tighten the nut one and one-quarter turns to the 9 o'clock position.

For 1/16, 1/8, and 3/16 in.; 2, 3, and 4 mm tube fittings, tighten the nut only three-quarters turn to the 3 o'clock position (Fig. 1).

Fig. 1



6. Loosen the nut.
7. Remove the tube with preswaged ferrules from the preswaging tool. If the tube sticks in the preswaging tool, remove the tube by gently rocking it back and forth. Do not turn the tube (Fig. 2).

Fig. 2



8. Insert the tube with preswaged ferrules into the fitting body until the front ferrule seats against the fitting body.
9. While holding the fitting body steady, rotate the nut with a wrench to the previously pulled-up position; at this point, you will feel a significant increase in resistance.
10. Tighten the nut slightly (Fig. 3).

Fig. 3



⚠ Do not use the Swagelok gap inspection gauge with fittings that were assembled using the preswaging tool.

Hydraulic Swaging Units

Swagelok hydraulic swaging units preswage Swagelok ferrules onto tubing prior to assembly and provide Swagelok tube fitting connections that are 100 % gaugeable upon initial installation. Multihead hydraulic and air-actuated hydraulic swaging units:

- Place no initial strain on nut or fitting body threads or on body seal surfaces
- Are available with interchangeable fractional and metric tooling
- Fit neatly in a rugged plastic carrying case
- Reduce assembly and installation time and operator error.

Multihead (MHSU)



- Is available in two unit sizes, with tooling for:
 - 1/2 to 1 in. and 12 to 25 mm tubing and tube adapters
 - 1 to 2 in. and 25 to 50 mm tubing and tube adapters
- **Must** be used to install 1 1/4, 1 1/2, and 2 in. and 28, 30, 32, 38, and 50 mm Swagelok tube fittings
- Is standard with a tube marking feature to indicate when tube is properly bottomed in the unit
- Is available with a support base (as shown).
- Is available with stainless steel connection tubing in place of hydraulic hose; support base is required.

The MHSU cannot be used for SAF 2507™ tubing 1/2 in. and under or for medium-pressure tubing. For 5/8 and 3/4 in. SAF 2507 tubing, order the 1 in./25 mm and over unit and SAF 2507 tooling kit and gap inspection gauges.

Hydraulic Swaging Units

Air-Actuated (AHSU)



- Requires only one unit with interchangeable tooling to swage 1/4 to 1/2 in. and 6 to 12 mm Swagelok tube fitting ferrule sizes
- Requires no threading of nut on or off the tooling

The AHSU cannot be used for SAF 2507 tubing or for medium-pressure tubing.

Additional Information, MHSU and AHSU

See the Swagelok *Gaugeable Tube Fittings and Adapters* catalog, MS-01-140. For instructions, see *Multihead Hydraulic Swaging Unit (MHSU) Setup and Operation Instructions*, MS-12-37, and *Air-Actuated Hydraulic Swaging Unit (AHSU) Setup and Operation Instructions*, MS-12-38.

Tubing Installation

Tubing properly selected and handled, when combined with the quality of Swagelok fittings, will give you leak-tight systems. Properly installed on such tubing, Swagelok fittings provide reliable service under a wide variety of fluid applications.

When installing fittings near tube bends, there must be a sufficient straight length of tubing to allow the tube to be bottomed in the Swagelok fitting (see tables below).

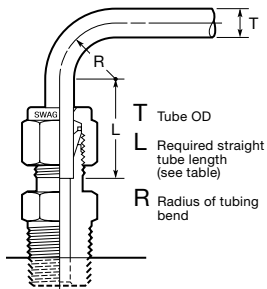

Fractional, in.	
T Tube OD	L ^①
1/16	1/2
1/8	23/32
3/16	3/4
1/4	13/16
5/16	7/8
3/8	15/16
1/2	1 3/16
5/8	1 1/4
3/4	
7/8	1 5/16
1	1 1/2
1 1/4	2
1 1/2	2 13/32
2	3 1/4

① Required straight tube length.

Metric, mm	
T Tube OD	L ^①
3	19
6	21
8	23
10	25
12	31
14	32
15	
16	
18	34
20	
22	34
25	40
28	46
30	50
32	54
38	63
50	80

Tubing Selection

- Metal tubing material should be softer than fitting material. For example, stainless steel tubing should not be used with brass fittings.
- When tubing and fittings are made of the same material, tubing must be fully annealed.
- Always use an insert with extremely soft or pliable plastic tubing.
- Extremes of wall thickness should always be checked against the suggested minimum and maximum wall thickness limitations.
- Surface finish is very important to proper sealing. Tubing with any kind of depression, scratch, raised portion, or other surface defect will be difficult to seal, particularly in gas service.
- Tubing that is oval and will not easily fit through fitting nuts, ferrules, and bodies should never be forced into the fitting.

Gas Service

Gases (air, hydrogen, helium, nitrogen, etc.) have very small molecules that can escape through even the most minute leak path. Some surface defects on the tubing can provide such a leak path. As tube outside diameter (OD) increases, so does the likelihood of a scratch or other surface defect interfering with proper sealing.

The most successful connection for gas service will occur if all installation instructions are carefully followed and the heavier wall thicknesses of tubing on the following tables are selected.

A heavy-wall tube resists ferrule action more than a thin-wall tube, allowing the ferrules to coin out minor surface imperfections. A thin-wall tube offers less resistance to ferrule action during installation, reducing the chance of coining out surface defects, such as scratches. Within the applicable suggested allowable working pressure table, select a tube wall thickness whose working pressure is *outside* of the shaded areas.

Fractional Carbon Steel Tubing

Allowable working pressures are calculated from an S value of 15 700 psi (108.2 MPa) for ASTM A179 tubing at -20 to 100°F (-28 to 37°C), as listed in ASME B31.3. For working pressure in accordance with ASME B31.1, multiply by 0.85.

Suggested Ordering Information

High-quality, soft annealed seamless carbon steel hydraulic tubing, ASTM A179 or equivalent. Hardness not to exceed 72 HRB or 130 HV. Tubing to be free of scratches, suitable for bending and flaring.

Tube OD in.	Tube Wall Thickness, in.												Swagelok Fitting Series	
	0.028	0.035	0.049	0.065	0.083	0.095	0.109	0.120	0.134	0.148	0.165	0.180		0.220
	Working Pressure, psig Note: For gas service, select a tube wall thickness outside of the shaded area. (See Gas Service, page 22.)													
1/8	8000	10 200												200
3/16	5100	6 600	9600											300
1/4	3700	4 800	7000	9600										400
5/16		3 700	5500	7500										500
3/8		3 100	4500	6200										600
1/2		2 300	3200	4500	5900									810
5/8		1 800	2600	3500	4600	5300								1010
3/4			2100	2900	3700	4300	5100							1210
7/8			1800	2400	3200	3700	4300							1410
1			1500	2100	2700	3200	3700	4100						1610
1 1/4				1600	2100	2500	2900	3200	3600	4000	4600	5000		2000
1 1/2					1800	2000	2400	2600	2900	3300	3700	4100	5100	2400
2						1500	1700	1900	2100	2400	2700	3000	3700	3200

Metric Carbon Steel Tubing

Allowable working pressures are based on equations from ASME B31.3 for DIN 2391 tubing, using a stress value of 113 MPa (16 300 psi) and tensile strength of 340 MPa (49 300 psi).

Suggested Ordering Information

High-quality, soft annealed carbon steel tubing, DIN 2391 or equivalent. Hardness not to exceed 72 HRB or 130 HV. Tubing to be free of scratches, suitable for bending or flaring.

Tube OD mm	Tube Wall Thickness, mm														Swagelok Fitting Series			
	0.8	1.0	1.2	1.5	1.8	2.0	2.2	2.5	2.8	3.0	3.5	4.0	4.5					
	Working Pressure, bar Note: For gas service, select a tube wall thickness outside of the shaded area. (See Gas Service, page 22.)																	
3	630	790																3M0
6	290	370	460	590														6M0
8		270	330	430														8M0
10		210	260	330														10M0
12		170	210	270	330	380	420											12M0
14		150	180	230	280	320	350											14M0
15		140	170	210	260	290	330											15M0
16		130	150	200	240	270	300	350										16M0
18			140	170	210	240	270	310										18M0
20			120	160	190	210	240	270	310									20M0
22			110	140	170	190	210	240	280									22M0
25			100	120	150	170	180	210	240	260								25M0
28						150	160	190	210	230	270							28M0
30						140	150	170	200	210	250							30M0
32						130	140	160	180	200	230	270						32M0
38							120	130	150	160	190	230	260					38M0

Fractional Stainless Steel Seamless Tubing

Allowable working pressures are calculated from an S value of 20 000 psi (137.8 MPa) for ASTM A269 tubing at -20 to 100°F (-28 to 37°C), as listed in ASME B31.3 and ASME B31.1, except as noted.

For Welded Tubing

For welded and drawn tubing, a derating factor must be applied for weld integrity:

- for double-welded tubing, multiply pressure rating by 0.85
- for single-welded tubing, multiply pressure rating by 0.80.

Suggested Ordering Information

High-quality, fully annealed (Type 304, 304/304L, 316, 316/316L, 317, 317/317L) (seamless or welded and drawn) stainless steel hydraulic tubing, ASTM A269 or A213, or equivalent. Hardness not to exceed 90 HRB or 200 HV. Tubing to be free of scratches, suitable for bending and flaring. OD tolerances not to exceed ± 0.003 in. for 1/16 in. OD tubing.

Certain austenitic stainless tubing has an allowable ovality tolerance double the OD tolerance and may not fit into Swagelok precision tube fittings. Dual-certified grades such as 304/304L, 316/316L, and 317/317L meet the minimum chemistry and the mechanical properties of both alloy grades.

Tube OD in.	Tube Wall Thickness, in.													Swagelok Fitting Series			
	0.010	0.012	0.014	0.016	0.020	0.028	0.035	0.049	0.065	0.083	0.095	0.109	0.120		0.134	0.156	0.188
	Working Pressure, psig																
	Note: For gas service, select a tube wall thickness outside of the shaded area. (See Gas Service, page 22.)																
1/16	5600	6800	8100	9400	12 000												100
1/8						8500	10 900										200
3/16						5400	7 000	10 200									300
1/4						4000	5 100	7 500	10 200 ^①								400
5/16							4 000	5 800	8 000								500
3/8							3 300	4 800	6 500	7500 ^{①②}							600
1/2							2 600	3 700	5 100	6700							810
5/8								2 900	4 000	5200				6000			1010
3/4								2 400	3 300	4200				4900	5800		1210
7/8								2 000	2 800	3600				4200	4800		1410
1									2 400	3100				3600	4200	4700	1610
1 1/4										2400				2800	3300	3600	2000
1 1/2														2300	2700	3000	2400
2														2000	2200	2500	3200

① For higher pressures, see the Swagelok *Medium-Pressure Fittings* catalog, MS-02-335, or the Swagelok *High-Pressure Fittings* catalog, MS-01-34.

② Rating based on repeated pressure testing of the Swagelok tube fitting with a 4:1 design factor based upon hydraulic fluid leakage.

Metric Stainless Steel Seamless Tubing

Allowable working pressures are based on equations from ASME B31.3 and ASME B31.1 for EN ISO 1127 tubing (D4, T4 tolerance for 3 to 12 mm; D4, T3 tolerance 14 to 50 mm), using a stress value of 137.8 MPa (20 000 psi) and tensile strength of 516.4 MPa (74 900 psi), except as noted.

For Welded Tubing

For welded and drawn tubing, a derating factor must be applied for weld integrity:

- for double-welded tubing, multiply pressure rating by 0.85
- for single-welded tubing, multiply pressure rating by 0.80.

Suggested Ordering Information

High-quality, fully annealed (Type 304, 304/304L, 316, 316/316L, 317, 317/317L) stainless steel tubing, EN ISO 1127 or equivalent. Hardness not to exceed 90 HRB or 200 HV. Tubing to be free of scratches, suitable for bending or flaring. OD tolerances not to exceed ± 0.076 mm for 3 mm OD tubing.

Dual-certified grades such as 304/304L, 316/316L, and 317/317L meet the minimum chemistry and the mechanical properties of both alloy grades.

Tube OD mm	Tube Wall Thickness, mm													Swagelok Fitting Series		
	0.8	1.0	1.2	1.5	1.8	2.0	2.2	2.5	2.8	3.0	3.5	4.0	4.5		5.0	
	Working Pressure, bar															
	Note: For gas service, select a tube wall thickness outside of the shaded area. (See Gas Service, page 22.)															
3	670															3M0
6	310	420	540	710												6M0
8		310	390	520												8M0
10		240	300	400	510	580										10M0
12		200	250	330	410	470										12M0
14		160	200	270	340	380	430									14M0
15		150	190	250	310	360	400									15M0
16			170	230	290	330	370	400 ^①								16M0
18			150	200	260	290	320	370								18M0
20			140	180	230	260	290	330	380							20M0
22			140	160	200	230	260	300	340							22M0
25					180	200	230	260	290	320						25M0
28						180	200	230	260	280	330					28M0
30						170	180	210	240	260	310					30M0
32						160	170	200	220	240	290	330				32M0
38							140	160	190	200	240	270	310			38M0
50										150	180	210	240	270		50M0

① Rating based on repeated pressure testing of the Swagelok tube fitting with a 4:1 design factor based upon hydraulic fluid leakage.

Fractional Copper Tubing

Allowable working pressures are calculated from an S value of 6000 psi (41.3 MPa) for ASTM B75 and ASTM B88 tubing at -20 to 100°F (-28 to 37°C), as listed in ASME B31.3 and ASME B31.1.

Suggested Ordering Information

High-quality, soft annealed seamless copper tubing, ASTM B75 or equivalent. Also soft annealed (Temper O) copper water tube, type K or type L to ASTM B88.

Tube OD in.	Tube Wall Thickness, in.										Swagelok Fitting Series	
	0.028	0.030	0.035	0.049	0.065	0.083	0.095	0.109	0.120	0.134		
1/8	2700	3000	3600									200
3/16	1800	1900	2300	3400								300
1/4	1300	1400	1600	2500	3500							400
5/16			1300	1900	2700							500
3/8			1000	1600	2200							600
1/2			800	1100	1600	2100						810
5/8				900	1200	1600	1900					1010
3/4				700	1000	1300	1500	1800				1210
7/8				600	800	1100	1300	1500				1410
1				500	700	900	1100	1300	1500			1610
1 1/8					600	800	1000	1100	1300	1400		1810

Note: For gas service, select a tube wall thickness outside of the shaded area.
(See Gas Service, page 22.)

Working Pressure, psig

Ordering Numbers

Select a basic ordering number.

Example: **-100-6**

Add a material designator.

Example: **SS-100-6**

Minimum order quantities may apply to certain materials and configurations.

Material	Designator
316 SS	SS
Aluminum	A
Alloy 20	C20
Alloy 400	M
Alloy 600	INC
Alloy 625	625
Alloy 825	825
Alloy C-276	HC
Brass	B
Carbon steel	S
Nylon	NY
PTFE	T
Titanium	TI

Additional Products

- For SAF 2507 super duplex tube fittings, see the *Swagelok Gaugeable SAF 2507 Super Duplex Tube Fittings* catalog, MS-01-174.
- For alloy 400 tube fittings, see the *Swagelok Gaugeable Alloy 400 Mechanically Attached Pipe and Tube Fittings* catalog, MS-02-332.
- For PFA tube fittings, see the *Swagelok PFA Tube Fittings* catalog, MS-01-05.
- For heavy-wall tube fittings, see the *Swagelok High-Pressure Fittings* catalog, MS-01-34.
- For medium-pressure tube fittings, see the *Swagelok Medium-Pressure Fittings* catalog, MS-02-335.

Contact your authorized Swagelok sales and service representative about additional sizes and special alloys.

Unions



Union

Tube OD in.	Basic Ordering Number
1/16	-100-6
1/8	-200-6
3/16	-300-6
1/4	-400-6
5/16	-500-6
3/8	-600-6
1/2	-810-6
1/2	-810-6-0030 ^①
5/8	-1010-6
3/4	-1210-6
7/8	-1410-6
1	-1610-6
1 1/8	-1810-6
1 1/4	-2000-6
1 1/2	-2400-6
2	-3200-6

^① Bored through.

Tube OD mm	Basic Ordering Number
2	-2M0-6
3	-3M0-6
4	-4M0-6
6	-6M0-6
8	-8M0-6
10	-10M0-6
12	-12M0-6
14	-14M0-6
15	-15M0-6
16	-16M0-6
18	-18M0-6
20	-20M0-6
22	-22M0-6
25	-25M0-6
28	-28M0-6
30	-30M0-6
32	-32M0-6
38	-38M0-6
50	-50M0-6

Unions

**Union
(Metric to
Fractional)**

Tube OD		Basic Ordering Number
T, mm	Tx, in.	
2	1/8	-2M0-6-2
	1/4	-2M0-6-4
3	1/8	-3M0-6-2
4	1/8	-4M0-6-2
	1/4	-4M0-6-4
6	1/16	-6M0-6-1
	1/8	-6M0-6-2
	1/4	-6M0-6-4
	5/16	-6M0-6-5
	3/8	-6M0-6-6
8	1/4	-8M0-6-4
	3/8	-8M0-6-6
10	1/8	-10M0-6-2
	1/4	-10M0-6-4
	5/16	-10M0-6-5
	3/8	-10M0-6-6
12	1/4	-12M0-6-4
	5/16	-12M0-6-5
	3/8	-12M0-6-6
	1/2	-12M0-6-8
15	1/2	-15M0-6-8
16	5/8	-16M0-6-10
18	3/4	-18M0-6-12
20	1/2	-20M0-6-8
	1	-20M0-6-16
25	1	-25M0-6-16

Unions

**Reducing Union**

Tube OD, in.		Basic Ordering Number
T	Tx	
1/8	1/16	-200-6-1
3/16	1/16	-300-6-1
	1/8	-300-6-2
1/4	1/16	-400-6-1
	1/8	-400-6-2
	3/16	-400-6-3
5/16	1/8	-500-6-2
	1/4	-500-6-4
3/8	1/16	-600-6-1
	1/8	-600-6-2
	1/4	-600-6-4
	5/16	-600-6-5
1/2	1/8	-810-6-2
	1/4	-810-6-4
	3/8	-810-6-6
5/8	3/8	-1010-6-6
	1/2	-1010-6-8
3/4	1/4	-1210-6-4
	3/8	-1210-6-6
	1/2	-1210-6-8
	5/8	-1210-6-10
1	1/2	-1610-6-8
	3/4	-1610-6-12

Unions



Reducing Union

Tube OD, mm		Basic Ordering Number
T	Tx	
3	2	-3M0-6-2M
6	2	-6M0-6-2M
	3	-6M0-6-3M
	4	-6M0-6-4M
8	6	-8M0-6-6M
10	6	-10M0-6-6M
	8	-10M0-6-8M
12	6	-12M0-6-6M
	8	-12M0-6-8M
	10	-12M0-6-10M
16	10	-16M0-6-10M
	12	-16M0-6-12M
18	12	-18M0-6-12M
25	18	-25M0-6-18M
	20	-25M0-6-20M
30	18	-30M0-6-18M
	20	-30M0-6-20M
	25	-30M0-6-25M
32	18	-32M0-6-18M
	20	-32M0-6-20M
	25	-32M0-6-25M
38	20	-38M0-6-20M
	25	-38M0-6-25M
	30	-38M0-6-30M

Unions



Bulkhead Union

Tube OD in.	Basic Ordering Number
1/16	-100-61
1/8	-200-61
3/16	-300-61
1/4	-400-61
5/16	-500-61
3/8	-600-61
1/2	-810-61
5/8	-1010-61
3/4	-1210-61
1	-1610-61
1 1/4	-2000-61
1 1/2	-2400-61
2	-3200-61

Tube OD mm	Basic Ordering Number
3	-3M0-61
4	-4M0-61
6	-6M0-61
8	-8M0-61
10	-10M0-61
12	-12M0-61
14	-14M0-61
15	-15M0-61
16	-16M0-61
18	-18M0-61
20	-20M0-61
25	-25M0-61
30	-30M0-61
32	-32M0-61
38	-38M0-61



Bulkhead Reducing Union

Tube OD, in.		Basic Ordering Number
T	Tx	
1/8	1/16	-200-61-1
1/4	1/8	-400-61-2
3/8	1/4	-600-61-4
1/2	1/4	-810-61-4

Bulkhead Reducing Union (Metric to Fractional)

Tube OD		Basic Ordering Number
T, mm	Tx, in.	
6	1/8	-6M0-61-2

Male Connectors



NPT

Tube OD in.	NPT Size in.	Basic Ordering Number
1/16	1/16	-100-1-1
	1/8	-100-1-2
	1/4	-100-1-4
1/8	1/16	-200-1-1
	1/8	-200-1-2
	1/4	-200-1-4
	3/8	-200-1-6
	1/2	-200-1-8
3/16	1/8	-300-1-2
	1/4	-300-1-4
1/4	1/16	-400-1-1
	1/8	-400-1-2
	1/4	-400-1-4
	3/8	-400-1-6
	1/2	-400-1-8
	3/4	-400-1-12
5/16	1/8	-500-1-2
	1/4	-500-1-4
	3/8	-500-1-6
3/8	1/8	-600-1-2
	1/4	-600-1-4
	3/8	-600-1-6
	1/2	-600-1-8
	3/4	-600-1-12
	1	-600-1-16
1/2	1/8	-810-1-2
	1/4	-810-1-4
	3/8	-810-1-6
	1/2	-810-1-8
	3/4	-810-1-12
	1	-810-1-16

Tube OD in.	NPT Size in.	Basic Ordering Number
5/8	1/4	-1010-1-4
	3/8	-1010-1-6
	1/2	-1010-1-8
	3/4	-1010-1-12
3/4	3/8	-1210-1-6
	1/2	-1210-1-8
	3/4	-1210-1-12
	1	-1210-1-16
7/8	1/2	-1410-1-8
	3/4	-1410-1-12
	1	-1410-1-16
1	1/2	-1610-1-8
	3/4	-1610-1-12
	1	-1610-1-16
1 1/8	1	-1810-1-16
1 1/4	1	-2000-1-16
	1 1/4	-2000-1-20
1 1/2	1 1/2	-2400-1-24
2	2	-3200-1-32

Male Connectors

NPT



Tube OD mm	NPT Size in.	Basic Ordering Number
2	1/8	-2M0-1-2
3	1/8	-3M0-1-2
	1/4	-3M0-1-4
4	1/8	-4M0-1-2
	1/4	-4M0-1-4
6	1/8	-6M0-1-2
	1/4	-6M0-1-4
	3/8	-6M0-1-6
	1/2	-6M0-1-8
8	1/8	-8M0-1-2
	1/4	-8M0-1-4
	3/8	-8M0-1-6
	1/2	-8M0-1-8
10	1/8	-10M0-1-2
	1/4	-10M0-1-4
	3/8	-10M0-1-6
	1/2	-10M0-1-8
	3/4	-10M0-1-12
12	1/8	-12M0-1-2
	1/4	-12M0-1-4
	3/8	-12M0-1-6
	1/2	-12M0-1-8
	3/4	-12M0-1-12
14	1/4	-14M0-1-4
	3/8	-14M0-1-6
	1/2	-14M0-1-8
15	1/2	-15M0-1-8
16	3/8	-16M0-1-6
	1/2	-16M0-1-8
	3/4	-16M0-1-12
18	1/2	-18M0-1-8
	3/4	-18M0-1-12
20	1/2	-20M0-1-8
	3/4	-20M0-1-12
22	3/4	-22M0-1-12
	1	-22M0-1-16
25	1/2	-25M0-1-8
	3/4	-25M0-1-12
	1	-25M0-1-16
28	1	-28M0-1-16
	1 1/4	-28M0-1-20
30	1 1/4	-30M0-1-20
32	1 1/4	-32M0-1-20
38	1 1/2	-38M0-1-24

Male Connectors

ISO/BSP Tapered Thread (RT)



Tube OD in.	ISO Thread Size in.	Basic Ordering Number
1/8	1/8	-200-1-2RT
	1/4	-200-1-4RT
1/4	1/8	-400-1-2RT
	1/4	-400-1-4RT
	3/8	-400-1-6RT
	1/2	-400-1-8RT
5/16	1/8	-500-1-2RT
	1/4	-500-1-4RT
3/8	1/8	-600-1-2RT
	1/4	-600-1-4RT
	3/8	-600-1-6RT
	1/2	-600-1-8RT
	3/4	-600-1-12RT
1/2	1/4	-810-1-4RT
	3/8	-810-1-6RT
	1/2	-810-1-8RT
	3/4	-810-1-12RT
5/8	1/2	-1010-1-8RT
3/4	3/4	-1210-1-12RT
	1	-1210-1-16RT
1	3/4	-1610-1-12RT
	1	-1610-1-16RT
1 1/4	1 1/4	-2000-1-20RT

Male Connectors

**ISO/BSP
Tapered
Thread (RT)**



Tube OD mm	ISO Thread Size in.	Basic Ordering Number
2	1/8	-2M0-1-2RT
3	1/8	-3M0-1-2RT
	1/4	-3M0-1-4RT
4	1/8	-4M0-1-2RT
	1/4	-4M0-1-4RT
6	1/8	-6M0-1-2RT
	1/4	-6M0-1-4RT
	3/8	-6M0-1-6RT
	1/2	-6M0-1-8RT
8	1/8	-8M0-1-2RT
	1/4	-8M0-1-4RT
	3/8	-8M0-1-6RT
	1/2	-8M0-1-8RT
10	1/8	-10M0-1-2RT
	1/4	-10M0-1-4RT
	3/8	-10M0-1-6RT
	1/2	-10M0-1-8RT
	3/4	-10M0-1-12RT
12	1/4	-12M0-1-4RT
	3/8	-12M0-1-6RT
	1/2	-12M0-1-8RT
	3/4	-12M0-1-12RT
14	1/4	-14M0-1-4RT
	3/8	-14M0-1-6RT
15	1/2	-15M0-1-8RT
16	1/4	-16M0-1-4RT
	3/8	-16M0-1-6RT
	1/2	-16M0-1-8RT
	3/4	-16M0-1-12RT
18	1/2	-18M0-1-8RT
	3/4	-18M0-1-12RT
20	1/2	-20M0-1-8RT
	3/4	-20M0-1-12RT
22	3/4	-22M0-1-12RT
	1	-22M0-1-16RT
25	1/2	-25M0-1-8RT
	3/4	-25M0-1-12RT
	1	-25M0-1-16RT
28	1	-28M0-1-16RT
	1 1/4	-28M0-1-20RT
30	1 1/4	-30M0-1-20RT
32	1 1/4	-32M0-1-20RT
38	1 1/2	-38M0-1-24RT

Male Connectors



ISO/BSP Parallel Thread (RS)

Tube OD in.	ISO Thread Size in.	Basic Ordering Number
1/8	1/8	-200-1-2RS
	1/4	-200-1-4RS
	3/8	-200-1-6RS
1/4	1/8	-400-1-2RS
	1/4	-400-1-4RS
	3/8	-400-1-6RS
	1/2	-400-1-8RS
3/8	1/8	-600-1-2RS
	1/4	-600-1-4RS
	3/8	-600-1-6RS
	1/2	-600-1-8RS
1/2	1/4	-810-1-4RS
	3/8	-810-1-6RS
	1/2	-810-1-8RS
3/4	1/2	-1210-1-8RS
	3/4	-1210-1-12RS
1	1/2	-1610-1-8RS
	3/4	-1610-1-12RS
	1	-1610-1-16RS

Male Connectors

**ISO/BSP
Parallel
Thread (RS)**



Tube OD mm	ISO Thread Size in.	Basic Ordering Number
2	1/8	-2M0-1-2RS
3	1/8	-3M0-1-2RS
	1/4	-3M0-1-4RS
4	1/8	-4M0-1-2RS
6	1/8	-6M0-1-2RS
	1/4	-6M0-1-4RS
	3/8	-6M0-1-6RS
	1/2	-6M0-1-8RS
8	1/8	-8M0-1-2RS
	1/4	-8M0-1-4RS
	3/8	-8M0-1-6RS
	1/2	-8M0-1-8RS
10	1/4	-10M0-1-4RS
	3/8	-10M0-1-6RS
	1/2	-10M0-1-8RS
12	1/4	-12M0-1-4RS
	3/8	-12M0-1-6RS
	1/2	-12M0-1-8RS
	3/4	-12M0-1-12RS
14	3/8	-14M0-1-6RS
	1/2	-14M0-1-8RS
15	3/8	-15M0-1-6RS
	1/2	-15M0-1-8RS
	3/4	-15M0-1-12RS
16	3/8	-16M0-1-6RS
	1/2	-16M0-1-8RS
	3/4	-16M0-1-12RS
18	1/2	-18M0-1-8RS
	3/4	-18M0-1-12RS
20	1/2	-20M0-1-8RS
	3/4	-20M0-1-12RS
22	3/4	-22M0-1-12RS
	1	-22M0-1-16RS
25	3/4	-25M0-1-12RS
	1	-25M0-1-16RS
28	1	-28M0-1-16RS
	1 1/4	-28M0-1-20RS
30	1 1/4	-30M0-1-20RS
32	1 1/4	-32M0-1-20RS
38	1 1/2	-38M0-1-24RS

Male Connectors



ISO/BSP Parallel Thread (RP)

Tube OD in.	ISO Thread Size in.	Basic Ordering Number
1/8	1/8 1/4	-200-1-2RP -200-1-4RP
1/4	1/8 1/4	-400-1-2RP -400-1-4RP
1/2	3/8 1/2	-810-1-6RP -810-1-8RP
3/4	1/2 3/4	-1210-1-8RP -1210-1-12RP
1	1	-1610-1-16RP

Male Connectors



ISO/BSP Parallel Thread (RP)

Tube OD mm	ISO Thread Size in.	Basic Ordering Number
3	1/8	-3M0-1-2RP
	1/4	-3M0-1-4RP
4	1/8	-4M0-1-2RP
6	1/8	-6M0-1-2RP
	1/4	-6M0-1-4RP
	3/8	-6M0-1-6RP
	1/2	-6M0-1-8RP
8	1/8	-8M0-1-2RP
	1/4	-8M0-1-4RP
	3/8	-8M0-1-6RP
	1/2	-8M0-1-8RP
10	1/4	-10M0-1-4RP
	3/8	-10M0-1-6RP
	1/2	-10M0-1-8RP
12	1/4	-12M0-1-4RP
	3/8	-12M0-1-6RP
	1/2	-12M0-1-8RP
	3/4	-12M0-1-12RP
15	1/2	-15M0-1-8RP
16	3/8	-16M0-1-6RP
	1/2	-16M0-1-8RP
18	1/2	-18M0-1-8RP
	3/4	-18M0-1-12RP
20	1/2	-20M0-1-8RP
	3/4	-20M0-1-12RP
22	3/4	-22M0-1-12RP
	1	-22M0-1-16RP
25	3/4	-25M0-1-12RP
	1	-25M0-1-16RP
28	1	-28M0-1-16RP
	1 1/4	-28M0-1-20RP
30	1 1/4	-30M0-1-20RP
32	1 1/4	-32M0-1-20RP
38	1 1/2	-38M0-1-24RP

Male Connectors



Bulkhead NPT

Tube OD in.	NPT Size in.	Basic Ordering Number
1/8	1/8	-200-11-2
1/4	1/8	-400-11-2
	1/4	-400-11-4
3/8	1/4	-600-11-4
	3/8	-600-11-6
	1/2	-600-11-8
1/2	3/8	-810-11-6
	1/2	-810-11-8
3/4	3/4	-1210-11-12
1	1	-1610-11-16

Tube OD mm	NPT Size in.	Basic Ordering Number
6	1/8	-6M0-11-2
	1/4	-6M0-11-4
12	1/2	-12M0-11-8

Male Connectors

SAE/MS Straight Thread (ST)



Tube OD in.	SAE/MS Thread Size	Basic Ordering Number
1/8	5/16-24	-200-1-2ST
	7/16-20	-200-1-4ST
	9/16-18	-200-1-6ST
1/4	5/16-24	-400-1-2ST
	7/16-20	-400-1-4ST
	9/16-18	-400-1-6ST
	3/4-16	-400-1-8ST
	7/8-14	-400-1-10ST
5/16	1/2-20	-500-1-5ST
3/8	7/16-20	-600-1-4ST
	9/16-18	-600-1-6ST
	3/4-16	-600-1-8ST
	7/8-14	-600-1-10ST
1/2	9/16-18	-810-1-6ST
	3/4-16	-810-1-8ST
	7/8-14	-810-1-10ST
	1 1/16-12	-810-1-12ST
5/8	3/4-16	-1010-1-8ST
	7/8-14	-1010-1-10ST
3/4	3/4-16	-1210-1-8ST
	1 1/16-12	-1210-1-12ST
	1 5/16-12	-1210-1-16ST
7/8	1 3/16-12	-1410-1-14ST
1	1 1/16-12	-1610-1-12ST
	1 5/16-12	-1610-1-16ST
1 1/4	1 5/8-12	-2000-1-20ST
1 1/2	1 7/8-12	-2400-1-24ST
2	2 1/2-12	-3200-1-32ST

Tube OD mm	SAE/MS Thread Size	Basic Ordering Number
6	9/16-18	-6M0-1-6ST
10	9/16-18	-10M0-1-6ST
	3/4-16	-10M0-1-8ST
12	7/16-20	-12M0-1-4ST
	9/16-18	-12M0-1-6ST
	3/4-16	-12M0-1-8ST

Long SAE/MS Straight Thread (ST)

Tube OD in.	SAE/MS Thread Size	Basic Ordering Number
1/4	7/16-20	-400-1L-4ST
1/2	3/4-16	-810-1L-8ST

Male Connectors



O-Seal (SAE/MS Straight Thread)

Tube OD in.	SAE/MS Thread Size	Basic Ordering Number
1/16	5/16-24	-100-1-OR
1/8	5/16-24	-200-1-OR
3/16	3/8-24	-300-1-OR
1/4	7/16-20	-400-1-OR
5/16	1/2-20	-500-1-OR
3/8	9/16-18	-600-1-OR
1/2	3/4-16	-810-1-OR
3/4	1 1/16-12	-1210-1-OR
1	1 5/16-12	-1610-1-OR



O-Seal (NPT)

Tube OD in.	NPT Size in.	Basic Ordering Number
1/8	1/8	-200-1-2-OR
1/4	1/8	-400-1-2-OR
	1/4	-400-1-4-OR
3/8	1/4	-600-1-4-OR
	3/8	-600-1-6-OR
	1/2	-600-1-8-OR
1/2	1/2	-810-1-8-OR

Male Connectors



AN Fitting

Tube OD in.	AN Tube Flare Size in.	Basic Ordering Number
1/16	1/8	-100-6-2AN
1/8	1/8 1/4	-200-6-2AN -200-6-4AN
1/4	1/4	-400-6-4AN
5/16	5/16	-500-6-5AN
3/8	1/4 3/8	-600-6-4AN -600-6-6AN
1/2	1/2	-810-6-8AN
3/4	3/4	-1210-6-12AN
1	1	-1610-6-16AN



AN Bulkhead Fitting

Tube OD in.	AN Tube Flare Size in.	Basic Ordering Number
1/4	1/4	-400-61-4AN
3/8	3/8	-600-61-6AN
1/2	1/2	-810-61-8AN
3/4	3/4	-1210-61-12AN
1	1	-1610-61-16AN

Male Connectors



10-32 Thread

Tube OD in.	Basic Ordering Number
1/8	-200-1-0157
1/4	-400-1-0256



M5 × 0.8 Thread

Tube OD mm	Basic Ordering Number
6	-6M0-1-0046

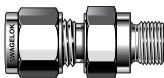

Metric Thread (RS)

Tube OD mm	Basic Ordering Number
6	-6M0-1-M10X1.0RS
	-6M0-1-M12X1.0RS
12	-12M0-1-M16X1.5RS

Weld Connectors



Tube Socket Weld

Tube OD in.	Socket Weld Size in.	Basic Ordering Number
1/8	1/8	-200-6-2W
1/4	1/4	-400-6-4W
3/8	3/8	-600-6-6W
1/2	1/2	-810-6-8W
3/4	3/4	-1210-6-12W
1	1	-1610-6-16W



Male Pipe Weld (Fractional)

Tube OD in.	Pipe Weld Size in.	Basic Ordering Number
1/8	1/8	-200-1-2W
3/16	1/8	-300-1-2W
1/4	1/8 1/4	-400-1-2W -400-1-4W
5/16	1/8 1/4	-500-1-2W -500-1-4W
3/8	1/4 3/8 1/2 3/4	-600-1-4W -600-1-6W -600-1-8W -600-1-12W
1/2	3/8 1/2 3/4 1	-810-1-6W -810-1-8W -810-1-12W -810-1-16W
5/8	1/2	-1010-1-8W
3/4	1/2 3/4	-1210-1-8W -1210-1-12W
1	1	-1610-1-16W
1 1/4	1 1/4	-2000-1-20W
1 1/2	1 1/2	-2400-1-24W
2	2	-3200-1-32W

Weld Connectors



Male Pipe Weld (Metric to Fractional)

Tube OD mm	Pipe Weld Size in.	Basic Ordering Number
3	1/8	-3M0-1-2W
4	1/8	-4M0-1-2W
6	1/8	-6M0-1-2W
	1/4	-6M0-1-4W
8	1/8	-8M0-1-2W
	1/4	-8M0-1-4W
	1/2	-8M0-1-8W
10	1/4	-10M0-1-4W
	3/8	-10M0-1-6W
	1/2	-10M0-1-8W
12	1/4	-12M0-1-4W
	3/8	-12M0-1-6W
	1/2	-12M0-1-8W
	3/4	-12M0-1-12W
14	3/8	-14M0-1-6W
15	1/2	-15M0-1-8W
16	1/2	-16M0-1-8W
18	1/2	-18M0-1-8W
30	1 1/4	-30M0-1-20W
32	1 1/4	-32M0-1-20W
38	1 1/2	-38M0-1-24W

Female Connectors



NPT

Tube OD in.	NPT Size in.	Basic Ordering Number
1/16	1/16	-100-7-1
	1/8	-100-7-2
1/8	1/8	-200-7-2
	1/4	-200-7-4
3/16	1/8	-300-7-2
1/4	1/8	-400-7-2
	1/4	-400-7-4
	3/8	-400-7-6
	1/2	-400-7-8
5/16	1/8	-500-7-2
	1/4	-500-7-4
3/8	1/8	-600-7-2
	1/4	-600-7-4
	3/8	-600-7-6
	1/2	-600-7-8
	3/4	-600-7-12
1/2	1/4	-810-7-4
	3/8	-810-7-6
	1/2	-810-7-8
	3/4	-810-7-12
5/8	3/8	-1010-7-6
	1/2	-1010-7-8
	3/4	-1010-7-12
3/4	1/2	-1210-7-8
	3/4	-1210-7-12
7/8	3/4	-1410-7-12
1	3/4	-1610-7-12
	1	-1610-7-16
1 1/4	1 1/4	-2000-7-20
1 1/2	1 1/2	-2400-7-24
2	2	-3200-7-32

Female Connectors



NPT

Tube OD mm	NPT Size in.	Basic Ordering Number
3	1/8	-3M0-7-2
	1/4	-3M0-7-4
4	1/8	-4M0-7-2
6	1/8	-6M0-7-2
	1/4	-6M0-7-4
	3/8	-6M0-7-6
	1/2	-6M0-7-8
8	1/8	-8M0-7-2
	1/4	-8M0-7-4
	3/8	-8M0-7-6
	1/2	-8M0-7-8
10	1/4	-10M0-7-4
	3/8	-10M0-7-6
	1/2	-10M0-7-8
12	1/4	-12M0-7-4
	3/8	-12M0-7-6
	1/2	-12M0-7-8
15	1/2	-15M0-7-8
16	1/2	-16M0-7-8
20	1/2	-20M0-7-8
	3/4	-20M0-7-12
22	3/4	-22M0-7-12
	1	-22M0-7-16
25	3/4	-25M0-7-12
	1	-25M0-7-16

Female Connectors

**ISO/BSP
Tapered
Thread (RT)**



Tube OD in.	ISO Thread Size in.	Basic Ordering Number
1/8	1/8	-200-7-2RT
1/4	1/8	-400-7-2RT
	1/4	-400-7-4RT
	3/8	-400-7-6RT
	1/2	-400-7-8RT
3/8	1/4	-600-7-4RT
	3/8	-600-7-6RT
	1/2	-600-7-8RT
1/2	1/4	-810-7-4RT
	3/8	-810-7-6RT
	1/2	-810-7-8RT

Tube OD mm	ISO Thread Size in.	Basic Ordering Number
3	1/8	-3M0-7-2RT
6	1/8	-6M0-7-2RT
	1/4	-6M0-7-4RT
	3/8	-6M0-7-6RT
	1/2	-6M0-7-8RT
8	1/8	-8M0-7-2RT
	1/4	-8M0-7-4RT
	3/8	-8M0-7-6RT
	1/2	-8M0-7-8RT
10	1/8	-10M0-7-2RT
	1/4	-10M0-7-4RT
	3/8	-10M0-7-6RT
	1/2	-10M0-7-8RT
12	1/8	-12M0-7-2RT
	1/4	-12M0-7-4RT
	3/8	-12M0-7-6RT
	1/2	-12M0-7-8RT
	3/4	-12M0-7-12RT
15	3/8	-15M0-7-6RT
	1/2	-15M0-7-8RT
20	1/2	-20M0-7-8RT
	3/4	-20M0-7-12RT
22	3/4	-22M0-7-12RT
	1	-22M0-7-16RT
25	3/4	-25M0-7-12RT
	1	-25M0-7-16RT

Female Connectors



ISO/BSP Parallel Thread (RJ)

ISO/BSP parallel thread (RJ) fittings are available in stainless steel only.

Tube OD in.	ISO Thread Size in.	Ordering Number
1/4	1/4	SS-400-7-4RJ
	3/8	SS-400-7-6RJ
	1/2	SS-400-7-8RJ
5/16	1/4	SS-500-7-4RJ
	1/2	SS-500-7-8RJ
3/8	1/4	SS-600-7-4RJ
	3/8	SS-600-7-6RJ
	1/2	SS-600-7-8RJ
1/2	1/4	SS-810-7-4RJ
	3/8	SS-810-7-6RJ
	1/2	SS-810-7-8RJ

Tube OD mm.	ISO Thread Size in.	Ordering Number
6	1/4	SS-6M0-7-4RJ
	3/8	SS-6M0-7-6RJ
	1/2	SS-6M0-7-8RJ
8	1/4	SS-8M0-7-4RJ
	3/8	SS-8M0-7-6RJ
	1/2	SS-8M0-7-8RJ
10	1/4	SS-10M0-7-4RJ
	3/8	SS-10M0-7-6RJ
	1/2	SS-10M0-7-8RJ
12	1/4	SS-12M0-7-4RJ
	3/8	SS-12M0-7-6RJ
	1/2	SS-12M0-7-8RJ

ISO/BSP Parallel Thread (RP)

Tube OD mm	ISO Thread Size in.	Basic Ordering Number
6	1/8	-6M0-7-2RP
	1/4	-6M0-7-4RP
22	3/4	-22M0-7-12RP
25	1	-25M0-7-16RP

Female Connectors



ISO/BSP Parallel Thread (RG, Gauge)

Tube OD in.	ISO Thread Size in.	Basic Ordering Number
1/8	1/4	-200-7-4RG
1/4	1/8	-400-7-2RG
	1/4	-400-7-4RG
	3/8	-400-7-6RG
	1/2	-400-7-8RG
5/16	1/4	-500-7-4RG
	1/2	-500-7-8RG
3/8	1/4	-600-7-4RG
	3/8	-600-7-6RG
	1/2	-600-7-8RG
1/2	3/8	-810-7-6RG
	1/2	-810-7-8RG

Tube OD mm	ISO Thread Size in.	Basic Ordering Number
3	1/4	-3M0-7-4RG
6	1/8	-6M0-7-2RG
	1/4	-6M0-7-4RG
	3/8	-6M0-7-6RG
	1/2	-6M0-7-8RG
8	1/4	-8M0-7-4RG
	3/8	-8M0-7-6RG
	1/2	-8M0-7-8RG
10	1/4	-10M0-7-4RG
	3/8	-10M0-7-6RG
	1/2	-10M0-7-8RG
12	1/4	-12M0-7-4RG
	3/8	-12M0-7-6RG
	1/2	-12M0-7-8RG
20	1/2	-20M0-7-8RG
22	1/2	-22M0-7-8RG

Female Connectors



Bulkhead NPT

Tube OD in.	NPT Size in.	Basic Ordering Number
1/8	1/8	-200-71-2
1/4	1/8 1/4	-400-71-2 -400-71-4
3/8	1/4	-600-71-4
1/2	3/8 1/2	-810-71-6 -810-71-8

Tube OD mm	NPT Size in.	Basic Ordering Number
6	1/4	-6M0-71-4
12	1/2	-12M0-71-8

Reducers

Reducer (Fractional)



Tube OD, in.		Basic Ordering Number
T	T _x	
1/16	1/8	-100-R-2
	1/4	-100-R-4
1/8	1/16	-200-R-1
	1/8	-200-R-2
	3/16	-200-R-3
	1/4	-200-R-4
	3/8	-200-R-6
	1/2	-200-R-8
3/16	1/8	-300-R-2
	1/4	-300-R-4
1/4	1/8	-400-R-2
	3/16	-400-R-3
	1/4	-400-R-4
	5/16	-400-R-5
	3/8	-400-R-6
	1/2	-400-R-8
	5/8	-400-R-10
	3/4	-400-R-12
5/16	3/8	-500-R-6
	1/2	-500-R-8
3/8	1/4	-600-R-4
	3/8	-600-R-6
	1/2	-600-R-8
	5/8	-600-R-10
	3/4	-600-R-12
1/2	1/4	-810-R-4
	3/8	-810-R-6
	1/2	-810-R-8
	5/8	-810-R-10
	3/4	-810-R-12
5/8	1	-810-R-16
	3/4	-1010-R-12
	7/8	-1010-R-14
3/4	1	-1010-R-16
	1/2	-1210-R-8
1	1	-1210-R-16
	1 1/4	-1610-R-20 ^①
	1 1/2	-1610-R-24 ^①
1 1/4	2	-1610-R-32 ^①
	1 1/2	-2000-R-24 ^①
1 1/2	2	-2000-R-32 ^①
	2	-2400-R-32 ^①

① Furnished with nut and preswaged ferrules.

Reducers

Reducer
(Metric)

Tube OD, mm		Basic Ordering Number
T	Tx	
2	3	-2M0-R-3M
3	4	-3M0-R-4M
	6	-3M0-R-6M
	10	-3M0-R-10M
4	6	-4M0-R-6M
6	3	-6M0-R-3M
	8	-6M0-R-8M
	10	-6M0-R-10M
	12	-6M0-R-12M
	18	-6M0-R-18M
8	6	-8M0-R-6M
	10	-8M0-R-10M
	12	-8M0-R-12M
10	6	-10M0-R-6M
	8	-10M0-R-8M
	12	-10M0-R-12M
	15	-10M0-R-15M
	18	-10M0-R-18M
12	6	-12M0-R-6M
	8	-12M0-R-8M
	10	-12M0-R-10M
	16	-12M0-R-16M
	18	-12M0-R-18M
	20	-12M0-R-20M
	22	-12M0-R-22M
25	-12M0-R-25M	
16	12	-16M0-R-12M
18	12	-18M0-R-12M
	16	-18M0-R-16M
	20	-18M0-R-20M
	22	-18M0-R-22M
	25	-18M0-R-25M
20	16	-20M0-R-16M
	18	-20M0-R-18M
	22	-20M0-R-22M
	25	-20M0-R-25M
22	18	-22M0-R-18M
	20	-22M0-R-20M
	25	-22M0-R-25M
25	18	-25M0-R-18M
	20	-25M0-R-20M

Reducers

**Reducer
(Metric to
Fractional)**

Tube OD		Basic Ordering Number
T, mm	Tx, in.	
2	1/8	-2M0-R-2
3	1/8	-3M0-R-2
	1/4	-3M0-R-4
4	1/4	-4M0-R-4
6	1/8	-6M0-R-2
	1/4	-6M0-R-4
	5/16	-6M0-R-5
	3/8	-6M0-R-6
	1/2	-6M0-R-8
8	1/4	-8M0-R-4
	3/8	-8M0-R-6
	1/2	-8M0-R-8
10	3/8	-10M0-R-6
	1/2	-10M0-R-8
12	1/2	-12M0-R-8
	3/4	-12M0-R-12
18	3/4	-18M0-R-12
	1	-18M0-R-16
25	1	-25M0-R-16

**Reducer
(Fractional to
Metric)**

Tube OD		Basic Ordering Number
T, in.	Tx, mm	
1/8	6	-200-R-6M

Reducers**Long Reducer**

Use only long reducers in female Swagelok end connections.

Tube OD, in.		Basic Ordering Number
T	Tx	
3/8	1/2	-600-RF-8

**Bulkhead Reducer**

Tube OD in,	Basic Ordering Number
1/8	-200-R1-2
1/4	-400-R1-4
3/8	-600-R1-6
1/2	-810-R1-8
5/8	-1010-R1-10
3/4	-1210-R1-12
1	-1610-R1-16

Port Connectors

Port Connector



1 in./25 mm and Under



Over 1 in./25 mm

Tube OD in.	Basic Ordering Number
1/16	-101-PC
1/8	-201-PC
1/4	-401-PC
5/16	-501-PC
3/8	-601-PC
1/2	-811-PC
5/8	-1011-PC
3/4	-1211-PC
1	-1611-PC
1 1/4	-2000-PC ^①
1 1/2	-2400-PC ^①
2	-3200-PC ^①

① Furnished with nut and preswaged ferrules.

Tube OD mm	Basic Ordering Number
3	-3M1-PC
6	-6M1-PC
8	-8M1-PC
10	-10M1-PC
12	-12M1-PC
15	-15M1-PC
16	-16M1-PC
18	-18M1-PC
20	-20M1-PC
25	-25M1-PC
28	-28M0-PC ^①
30	-30M0-PC ^①
32	-32M0-PC ^①
38	-38M0-PC ^①

① Furnished with nut and preswaged ferrules.

Port Connectors



Reducing Port Connector

Tube OD, in.		Basic Ordering Number
T	Tx	
1/8	1/16	-201-PC-1
1/4	1/16	-401-PC-1
	1/8	-401-PC-2
3/8	1/8	-601-PC-2
	1/4	-601-PC-4
1/2	1/4	-811-PC-4
	3/8	-811-PC-6
3/4	1/2	-1211-PC-8
1	1/2	-1611-PC-8
	3/4	-1611-PC-12

Tube OD, mm		Basic Ordering Number
T	Tx	
6	3	-6M1-PC-3M
8	6	-8M1-PC-6M
10	6	-10M1-PC-6M
	8	-10M1-PC-8M
12	6	-12M1-PC-6M
	8	-12M1-PC-8M
	10	-12M1-PC-10M
16	12	-16M1-PC-12M
28	25	-28M1-PC-25M
32	25	-32M1-PC-25M
38	25	-38M1-PC-25M

Caps and Plugs



Cap

Tube OD in.	Basic Ordering Number
1/16	-100-C
1/8	-200-C
3/16	-300-C
1/4	-400-C
5/16	-500-C
3/8	-600-C
1/2	-810-C
5/8	-1010-C
3/4	-1210-C
7/8	-1410-C
1	-1610-C
1 1/8	-1810-C
1 1/4	-2000-C
1 1/2	-2400-C
2	-3200-C

Tube OD mm	Basic Ordering Number
2	-2M0-C
3	-3M0-C
4	-4M0-C
6	-6M0-C
8	-8M0-C
10	-10M0-C
12	-12M0-C
14	-14M0-C
15	-15M0-C
16	-16M0-C
18	-18M0-C
20	-20M0-C
22	-22M0-C
25	-25M0-C
28	-28M0-C
30	-30M0-C
32	-32M0-C
38	-38M0-C

Caps and Plugs



Plug

Tube OD in.	Basic Ordering Number
1/16	-100-P
1/8	-200-P
3/16	-300-P
1/4	-400-P
5/16	-500-P
3/8	-600-P
1/2	-810-P
5/8	-1010-P
3/4	-1210-P
7/8	-1410-P
1	-1610-P
1 1/4	-2000-P
1 1/2	-2400-P
2	-3200-P

Tube OD mm	Basic Ordering Number
2	-2M0-P
3	-3M0-P
4	-4M0-P
6	-6M0-P
8	-8M0-P
10	-10M0-P
12	-12M0-P
15	-15M0-P
16	-16M0-P
18	-18M0-P
20	-20M0-P
22	-22M0-P
25	-25M0-P
28	-28M0-P
30	-30M0-P
32	-32M0-P
38	-38M0-P

Vent Protectors

Mud Dauber

Swagelok vent protectors, more commonly known as **mud dauber fittings**, protect open ends of instruments, tubing, outlet vents, and bleed-off lines.

The mesh wire screen prevents foreign objects, such as mud dauber insects, from entering and clogging various systems and causing damage.

Vent protectors are available in stainless steel and brass. To order brass, replace **SS** in the ordering number with **B**.

Example: **B**-MD-2



NPT Size in.	Ordering Number
1/8	SS-MD-2
1/4	SS-MD-4
3/8	SS-MD-6
1/2	SS-MD-8
3/4	SS-MD-12

Unions



Tube OD in.	Basic Ordering Number
1/16	-100-9
1/8	-200-9
3/16	-300-9
1/4	-400-9
5/16	-500-9
3/8	-600-9
1/2	-810-9
5/8	-1010-9
3/4	-1210-9
7/8	-1410-9
1	-1610-9
1 1/8	-1810-9
1 1/4	-2000-9
1 1/2	-2400-9
2	-3200-9

Tube OD mm	Basic Ordering Number
3	-3M0-9
4	-4M0-9
6	-6M0-9
8	-8M0-9
10	-10M0-9
12	-12M0-9
14	-14M0-9
15	-15M0-9
16	-16M0-9
18	-18M0-9
20	-20M0-9
22	-22M0-9
25	-25M0-9
28	-28M0-9
30	-30M0-9
32	-32M0-9
38	-38M0-9
50	-50M0-9

Male



NPT

Tube OD in.	NPT Size in.	Basic Ordering Number
1/16	1/16	-100-2-1
	1/8	-100-2-2
1/8	1/16	-200-2-1
	1/8	-200-2-2
	1/4	-200-2-4
3/16	1/8	-300-2-2
	1/4	-300-2-4
1/4	1/16	-400-2-1
	1/8	-400-2-2
	1/4	-400-2-4
	3/8	-400-2-6
	1/2	-400-2-8
5/16	1/8	-500-2-2
	1/4	-500-2-4
	3/8	-500-2-6
3/8	1/8	-600-2-2
	1/4	-600-2-4
	3/8	-600-2-6
	1/2	-600-2-8
	3/4	-600-2-12
1/2	1/4	-810-2-4
	3/8	-810-2-6
	1/2	-810-2-8
	3/4	-810-2-12
5/8	3/8	-1010-2-6
	1/2	-1010-2-8
	3/4	-1010-2-12
3/4	1/2	-1210-2-8
	3/4	-1210-2-12
7/8	3/4	-1410-2-12
1	3/4	-1610-2-12
	1	-1610-2-16
1 1/4	1 1/4	-2000-2-20
1 1/2	1 1/2	-2400-2-24
2	2	-3200-2-32

Male



NPT

Tube OD mm	NPT Size in.	Basic Ordering Number
3	1/8	-3M0-2-2
	1/4	-3M0-2-4
4	1/8	-4M0-2-2
	1/4	-4M0-2-4
6	1/8	-6M0-2-2
	1/4	-6M0-2-4
	3/8	-6M0-2-6
	1/2	-6M0-2-8
8	1/8	-8M0-2-2
	1/4	-8M0-2-4
	3/8	-8M0-2-6
	1/2	-8M0-2-8
10	1/8	-10M0-2-2
	1/4	-10M0-2-4
	3/8	-10M0-2-6
	1/2	-10M0-2-8
12	1/4	-12M0-2-4
	3/8	-12M0-2-6
	1/2	-12M0-2-8
	3/4	-12M0-2-12
15	1/2	-15M0-2-8
16	3/8	-16M0-2-6
	1/2	-16M0-2-8
	3/4	-16M0-2-12
18	1/2	-18M0-2-8
	3/4	-18M0-2-12
20	1/2	-20M0-2-8
	3/4	-20M0-2-12
22	3/4	-22M0-2-12
	1	-22M0-2-16
25	3/4	-25M0-2-12
	1	-25M0-2-16
30	1 1/4	-30M0-2-20
32	1 1/4	-32M0-2-20
38	1 1/2	-38M0-2-24

Male

**ISO/BSP
Tapered
Thread (RT)**

Tube OD in.	ISO Thread Size in.	Basic Ordering Number
1/8	1/8 1/4	-200-2-2RT -200-2-4RT
1/4	1/8 1/4 3/8 1/2	-400-2-2RT -400-2-4RT -400-2-6RT -400-2-8RT
5/16	1/4	-500-2-4RT
3/8	1/8 1/4 3/8	-600-2-2RT -600-2-4RT -600-2-6RT
1/2	1/4 3/8 1/2	-810-2-4RT -810-2-6RT -810-2-8RT
3/4	1/2	-1210-2-8RT
1	1	-1610-2-16RT

Male

**ISO/BSP
Tapered
Thread (RT)**

Tube OD mm	ISO Thread Size in.	Basic Ordering Number
3	1/8	-3M0-2-2RT
	1/4	-3M0-2-4RT
4	1/8	-4M0-2-2RT
	1/4	-4M0-2-4RT
6	1/8	-6M0-2-2RT
	1/4	-6M0-2-4RT
	3/8	-6M0-2-6RT
	1/2	-6M0-2-8RT
8	1/8	-8M0-2-2RT
	1/4	-8M0-2-4RT
	3/8	-8M0-2-6RT
	1/2	-8M0-2-8RT
10	1/4	-10M0-2-4RT
	3/8	-10M0-2-6RT
	1/2	-10M0-2-8RT
12	1/8	-12M0-2-2RT
	1/4	-12M0-2-4RT
	3/8	-12M0-2-6RT
	1/2	-12M0-2-8RT
	3/4	-12M0-2-12RT
14	1/2	-14M0-2-8RT
15	1/2	-15M0-2-8RT
16	3/8	-16M0-2-6RT
	1/2	-16M0-2-8RT
18	1/2	-18M0-2-8RT
	3/4	-18M0-2-12RT
20	1/2	-20M0-2-8RT
	3/4	-20M0-2-12RT
22	3/4	-22M0-2-12RT
	1	-22M0-2-16RT
25	3/4	-25M0-2-12RT
	1	-25M0-2-16RT
28	1	-28M0-2-16RT

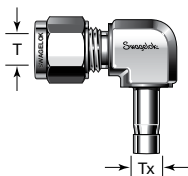
Male**Reducing**

Tube OD, mm		Basic Ordering Number
T	Tx	
6	6	-6M0-2R-6M
12	12	-12M0-2R-12M

**Positionable,
SAE/MS
Straight
Thread (ST)**

Tube OD in.	SAE/MS Thread Size	Basic Ordering Number
1/4	7/16-20	-400-2-4ST
	9/16-18	-400-2-6ST
5/16	1/2-20	-500-2-5ST
3/8	7/16-20	-600-2-4ST
	9/16-18	-600-2-6ST
	3/4-16	-600-2-8ST
1/2	9/16-18	-810-2-6ST
	3/4-16	-810-2-8ST
5/8	7/8-14	-1010-2-10ST
3/4	1 1/16-12	-1210-2-12ST
7/8	1 3/16-12	-1410-2-14ST
1	1 5/16-12	-1610-2-16ST
1 1/4	1 5/8-12	-2000-2-20ST
1 1/2	1 7/8-12	-2400-2-24ST
2	2 1/2-12	-3200-2-32ST

Male



**Positionable,
ISO/BSP
Parallel
Thread (PR)**

Tube OD in.	ISO Thread Size in.	Basic Ordering Number
1/4	1/8 1/4	-400-2-2PR -400-2-4PR
3/8	1/4 3/8	-600-2-4PR -600-2-6PR
1/2	1/4 3/8 1/2	-810-2-4PR -810-2-6PR -810-2-8PR
5/8	1/2	-1010-2-8PR
3/4	1/2 3/4	-1210-2-8PR -1210-2-12PR
1	3/4 1	-1610-2-12PR -1610-2-16PR

Tube OD mm	ISO Thread Size in.	Basic Ordering Number
6	1/8 1/4	-6M0-2-2PR -6M0-2-4PR
8	1/8 1/4	-8M0-2-2PR -8M0-2-4PR
10	1/4 3/8	-10M0-2-4PR -10M0-2-6PR
12	1/4 3/8 1/2 3/4	-12M0-2-4PR -12M0-2-6PR -12M0-2-8PR -12M0-2-12PR

Weld**Tube Socket
Weld**

Tube OD in.	Socket Weld Size in.	Basic Ordering Number
1/4	1/4	-400-9-4W
3/8	3/8	-600-9-6W
1/2	1/2	-810-9-8W
3/4	3/4	-1210-9-12W
1	1	-1610-9-16W

**Male Pipe
Weld**

Tube OD in.	Pipe Weld Size in.	Basic Ordering Number
1/4	1/8	-400-2-2W
	1/4	-400-2-4W
3/8	1/4	-600-2-4W
1/2	1/2	-810-2-8W
3/4	3/4	-1210-2-12W

Female



NPT

Tube OD in.	NPT Size in.	Basic Ordering Number
1/8	1/8	-200-8-2
	1/4	-200-8-4
3/16	1/8	-300-8-2
1/4	1/8	-400-8-2
	1/4	-400-8-4
	3/8	-400-8-6
	1/2	-400-8-8
5/16	1/8	-500-8-2
	1/4	-500-8-4
3/8	1/8	-600-8-2
	1/4	-600-8-4
	3/8	-600-8-6
	1/2	-600-8-8
1/2	1/4	-810-8-4
	3/8	-810-8-6
	1/2	-810-8-8
5/8	3/8	-1010-8-6
	1/2	-1010-8-8
3/4	1/2	-1210-8-8
	3/4	-1210-8-12
7/8	3/4	-1410-8-12
1	3/4	-1610-8-12
	1	-1610-8-16

Tube OD mm	NPT Size in.	Basic Ordering Number
6	1/8	-6M0-8-2
	1/4	-6M0-8-4
	1/2	-6M0-8-8
8	1/4	-8M0-8-4
10	1/8	-10M0-8-2
	1/4	-10M0-8-4
12	1/4	-12M0-8-4
	1/2	-12M0-8-8
16	1/2	-16M0-8-8

Male**NPT**

Tube OD in,	NPT Size in,	Basic Ordering Number
1/4	1/8	-400-5-2
	1/4	-400-5-4
3/8	1/8	-600-5-2
	1/4	-600-5-4
	3/8	-600-5-6
1/2	3/8	-810-5-6
	1/2	-810-5-8
3/4	3/4	-1210-5-12
1	1	-1610-5-16



**Positionable,
SAE/MS
Straight
Thread (ST)**

Tube OD in,	SAE/MS Thread Size	Basic Ordering Number
1/4	7/16-20	-400-5-4ST
3/8	9/16-18	-600-5-6ST
1/2	3/4-16	-810-5-8ST
3/4	1 1/16-12	-1210-5-12ST
1	1 5/16-12	-1610-5-16ST

Unions



Tube OD in.	Basic Ordering Number
1/16	-100-3
1/8	-200-3
3/16	-300-3
1/4	-400-3
5/16	-500-3
3/8	-600-3
1/2	-810-3
5/8	-1010-3
3/4	-1210-3
7/8	-1410-3
1	-1610-3
1 1/8	-1810-3
1 1/4	-2000-3
1 1/2	-2400-3
2	-3200-3

Tube OD mm	Basic Ordering Number
2	-2M0-3
3	-3M0-3
4	-4M0-3
6	-6M0-3
8	-8M0-3
10	-10M0-3
12	-12M0-3
14	-14M0-3
15	-15M0-3
16	-16M0-3
18	-18M0-3
20	-20M0-3
22	-22M0-3
25	-25M0-3
28	-28M0-3
30	-30M0-3
32	-32M0-3
38	-38M0-3
50	-50M0-3

Unions

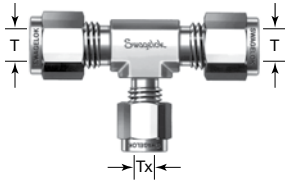

Reducing Union

Tube OD, in.		Basic Ordering Number
T	Tx	
3/8	1/4	-600-3-6-4
1/2	1/4	-810-3-8-4
	3/8	-810-3-8-6
5/8	3/8	-1010-3-10-6
3/4	3/8	-1210-3-12-6
	1/2	-1210-3-12-8
1	3/8	-1610-3-16-6
	1/2	-1610-3-16-8
	3/4	-1610-3-16-12
1 1/4	1	-2000-3-20-16
1 1/2	1	-2400-3-24-16
2	1	-3200-3-32-16

Tube OD, mm		Basic Ordering Number
T	Tx	
3	6	-3M0-3-3M-6M
8		-8M0-3-8M-6M
10		-10M0-3-10M-6M
12		-12M0-3-12M-6M
15	12	-15M0-3-15M-12M
16		-16M0-3-16M-12M
18		-18M0-3-18M-12M
22		-22M0-3-22M-12M
25		-25M0-3-25M-12M

Unions

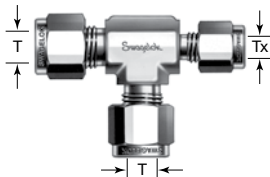

Reducing Union

Tube OD, in.		Basic Ordering Number
T	Tx	
3/8	1/4	-600-3-4-6

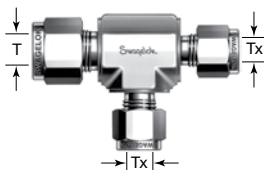

Tube OD, in.		Basic Ordering Number
T	Tx	
1/2	3/8	-810-3-6-6
5/8		-1010-3-6-6
3/4		-1210-3-6-6

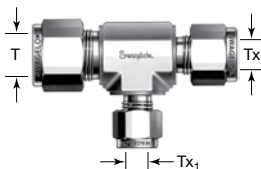

Tube OD, in.			Basic Ordering Number
T	Tx	Tx ₁	
5/8	1/2	3/8	-1010-3-8-6
3/4	1/2		-1210-3-8-6
1	3/4		-1610-3-12-6

Male**Branch,
NPT (TTM)**

Tube OD in.	NPT Size in.	Basic Ordering Number
1/8	1/8	-200-3TTM
	1/4	-200-3-4TTM
3/16	1/8	-300-3TTM
1/4	1/8	-400-3TTM
	1/4	-400-3-4TTM
5/16	1/8	-500-3TTM
3/8	1/4	-600-3TTM
	3/8	-600-3-6TTM
1/2	3/8	-810-3TTM
	1/2	-810-3-8TTM
5/8	1/2	-1010-3TTM
3/4	3/4	-1210-3TTM

Tube OD mm	NPT Size in.	Basic Ordering Number
6	1/8	-6M0-3TTM
	1/4	-6M0-3-4TTM
8	1/8	-8M0-3TTM
	1/4	-8M0-3-4TTM
10	1/4	-10M0-3TTM
12	3/8	-12M0-3TTM
	1/4	-12M0-3-4TTM
	1/2	-12M0-3-8TTM
16	1/2	-16M0-3TTM

Male

Run,
NPT (TMT)

Tube OD in.	NPT Size in.	Basic Ordering Number
1/8	1/8	-200-3TMT
	1/4	-200-3-4TMT
3/16	1/8	-300-3TMT
1/4	1/8	-400-3TMT
	1/4	-400-3-4TMT
5/16	1/8	-500-3TMT
3/8	1/4	-600-3TMT
	3/8	-600-3-6TMT
1/2	3/8	-810-3TMT
	1/2	-810-3-8TMT
5/8	1/2	-1010-3TMT
3/4	3/4	-1210-3TMT

Tube OD mm	NPT Size in.	Basic Ordering Number
6	1/8	-6M0-3TMT
	1/4	-6M0-3-4TMT
8	1/4	-8M0-3-4TMT
12	1/4	-12M0-3-4TMT
	1/2	-12M0-3-8TMT
16	1/2	-16M0-3TMT

Male

**Positionable
Branch,
SAE/MS
Straight
Thread (TTS)**

Tube OD in,	SAE/MS Thread Size	Basic Ordering Number
1/4	7/16-20	-400-3TTS
3/8	9/16-18	-600-3TTS
1/2	3/4-16	-810-3TTS
3/4	1 1/16-12	-1210-3TTS
1	1 5/16-12	-1610-3TTS
1 1/4	1 5/8-12	-2000-3TTS
1 1/2	1 7/8-12	-2400-3TTS
2	2 1/2-12	-3200-3TTS



**Positionable
Run,
SAE/MS
Straight
Thread (TST)**

Tube OD in,	SAE/MS Thread Size	Basic Ordering Number
1/4	7/16-20	-400-3TST
3/8	9/16-18	-600-3TST
1/2	3/4-16	-810-3TST
3/4	1 1/16-12	-1210-3TST
1	1 5/16-12	-1610-3TST
1 1/4	1 5/8-12	-2000-3TST
1 1/2	1 7/8-12	-2400-3TST
2	2 1/2-12	-3200-3TST

Male



**Positionable
Branch,
ISO/BSP
Parallel
Thread (TTR)**

Tube OD in.	ISO Thread Size in.	Basic Ordering Number
1/4	1/8 1/4	-400-3TTR -400-3-4TTR
3/8	1/4	-600-3TTR
1/2	3/8 1/2	-810-3TTR -810-3-8TTR
5/8	1/2	-1010-3TTR
3/4	3/4 1/2	-1210-3TTR -1210-3-8TTR
1	1	-1610-3TTR

Tube OD mm	ISO Thread Size in.	Basic Ordering Number
6	1/8 1/4	-6M0-3TTR -6M0-3-4TTR
8	1/8 1/4	-8M0-3TTR -8M0-3-4TTR
10	1/4	-10M0-3TTR
12	3/8 1/2	-12M0-3TTR -12M0-3-8TTR

Male



**Positionable
Run,
ISO/BSP
Parallel
Thread (TRT)**

Tube OD in.	ISO Thread Size in.	Basic Ordering Number
1/4	1/8 1/4	-400-3TRT -400-3-4TRT
3/8	1/4	-600-3TRT
1/2	3/8 1/2	-810-3TRT -810-3-8TRT
5/8	1/2	-1010-3TRT
3/4	3/4 1/2	-1210-3TRT -1210-3-8TRT
1	1	-1610-3TRT

Tube OD mm	ISO Thread Size in.	Basic Ordering Number
6	1/8 1/4	-6M0-3TRT -6M0-3-4TRT
8	1/8 1/4	-8M0-3TRT -8M0-3-4TRT
10	1/4	-10M0-3TRT
12	3/8 1/2	-12M0-3TRT -12M0-3-8TRT

Female

**Run,
NPT (TFT)**

Tube OD in.	NPT Size in.	Basic Ordering Number
1/8	1/8	-200-3TFT
1/4	1/8	-400-3TFT
	1/4	-400-3-4TFT
3/8	1/4	-600-3TFT
1/2	3/8	-810-3TFT
	1/2	-810-3-8TFT
3/4	3/4	-1210-3TFT
1	3/4	-1610-3-12TFT
	1	-1610-3TFT

Tube OD mm	NPT Size in.	Basic Ordering Number
6	1/8	-6M0-3TFT
	1/4	-6M0-3-4TFT
8	1/8	-8M0-3TFT
	1/4	-8M0-3-4TFT
10	1/4	-10M0-3TFT
12	1/4	-12M0-3-4TFT
	3/8	-12M0-3TFT
	1/2	-12M0-3-8TFT
16	1/2	-16M0-3TFT

Female

**Branch,
NPT (TTF)**

Tube OD in.	NPT Size in.	Basic Ordering Number
1/8	1/8	-200-3TTF
1/4	1/8	-400-3TTF
	1/4	-400-3-4TTF
3/8	1/4	-600-3TTF
	3/8	-600-3-6TTF
	1/2	-600-3-8TTF
1/2	1/4	-810-3-4TTF
	3/8	-810-3TTF
	1/2	-810-3-8TTF
5/8	1/2	-1010-3TTF
3/4	3/4	-1210-3TTF
1	3/4	-1610-3-12TTF
	1	-1610-3TTF

Tube OD mm	NPT Size in.	Basic Ordering Number
6	1/8	-6M0-3TTF
	1/4	-6M0-3-4TTF
8	1/8	-8M0-3TTF
	1/4	-8M0-3-4TTF
10	1/4	-10M0-3TTF
12	1/4	-12M0-3-4TTF
	3/8	-12M0-3TTF
	1/2	-12M0-3-8TTF
16	1/2	-16M0-3TTF

Union



Tube OD in.	Basic Ordering Number
1/8	-200-4
1/4	-400-4
5/16	-500-4
3/8	-600-4
1/2	-810-4
3/4	-1210-4
1	-1610-4

Tube OD mm	Basic Ordering Number
3	-3M0-4
6	-6M0-4
8	-8M0-4
10	-10M0-4
12	-12M0-4
16	-16M0-4
18	-18M0-4
20	-20M0-4
22	-22M0-4
25	-25M0-4

Kwik-Clamp Flange To Swagelok Tube Fitting

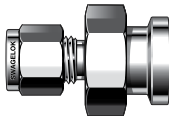

Tube OD in.	Flange Size in.	Ordering Number
1/4	1/2	SS-400-SC-8
	3/4	SS-400-SC-12
	1	SS-400-SC-16
	1 1/2	SS-400-SC-24
3/8	1/2	SS-600-SC-8
	3/4	SS-600-SC-12
	1	SS-600-SC-16
	1 1/2	SS-600-SC-24
1/2	1/2	SS-810-SC-8
	3/4	SS-810-SC-12
	1	SS-810-SC-16
	1 1/2	SS-810-SC-24
1	1	SS-1610-SC-16
	2	SS-1610-SC-32

Male

NPT



1 in./25 mm and Under



Over 1 in./25 mm

Tube OD in,	NPT Size in.	Basic Ordering Number
1/8	1/8	-2-TA-1-2
	1/4	-2-TA-1-4
3/16	1/8	-3-TA-1-2
	1/4	-3-TA-1-4
1/4	1/8	-4-TA-1-2
	1/4	-4-TA-1-4
	3/8	-4-TA-1-6
	1/2	-4-TA-1-8
5/16	1/8	-5-TA-1-2
	1/4	-5-TA-1-4
3/8	1/8	-6-TA-1-2
	1/4	-6-TA-1-4
	3/8	-6-TA-1-6
	1/2	-6-TA-1-8
1/2	1/4	-8-TA-1-4
	3/8	-8-TA-1-6
	1/2	-8-TA-1-8
5/8	1/2	-10-TA-1-8
3/4	1/2	-12-TA-1-8
	3/4	-12-TA-1-12
1	3/4	-16-TA-1-12
	1	-16-TA-1-16
1 1/4	1 1/4	-20-TA-1-20 ^①
1 1/2	1 1/2	-24-TA-1-24 ^①
2	2	-32-TA-1-32 ^①

⚠ Swagelok tube adapters are to be used ONLY in Swagelok tube fittings. Use in fittings made by other manufacturers may result in leakage or slippage.

Tube OD mm	NPT Size in.	Basic Ordering Number
6	1/8	-6-MTA-1-2
	1/4	-6-MTA-1-4
8	1/4	-8-MTA-1-4
	3/8	-8-MTA-1-6
10	1/4	-10-MTA-1-4
	3/8	-10-MTA-1-6
	1/2	-10-MTA-1-8
12	1/4	-12-MTA-1-4
	1/2	-12-MTA-1-8
28	1	-28-MTA-1-16 ^①
	1 1/4	-28-MTA-1-20 ^①
30	1	-30-MTA-1-16 ^①
	1 1/4	-30-MTA-1-20 ^①
32	1 1/4	-32-MTA-1-20 ^①
38	1 1/2	-38-MTA-1-24 ^①

① Furnished with nut and preswaged ferrules.

Male

**ISO/BSP
Tapered
Thread (RT)**



1 in./25 mm and Under



Over 1 in./25 mm

Tube OD in.	ISO Thread Size in.	Basic Ordering Number
1/8	1/8	-2-TA-1-2RT
	1/4	-2-TA-1-4RT
1/4	1/8	-4-TA-1-2RT
	1/4	-4-TA-1-4RT
3/8	1/4	-6-TA-1-4RT
	3/8	-6-TA-1-6RT
	1/2	-6-TA-1-8RT
1/2	1/4	-8-TA-1-4RT
	3/8	-8-TA-1-6RT
	1/2	-8-TA-1-8RT
3/4	3/4	-12-TA-1-12RT
1	1	-16-TA-1-16RT

Tube OD mm	ISO Thread Size in.	Basic Ordering Number
6	1/8	-6-MTA-1-2RT
	1/4	-6-MTA-1-4RT
8	1/4	-8-MTA-1-4RT
10	1/4	-10-MTA-1-4RT
	3/8	-10-MTA-1-6RT
12	1/4	-12-MTA-1-4RT
	3/8	-12-MTA-1-6RT
	1/2	-12-MTA-1-8RT
28	1	-28-MTA-1-16RT ^①
	1 1/4	-28-MTA-1-20RT ^①
30	1 1/4	-30-MTA-1-20RT ^①
32	1 1/4	-32-MTA-1-20RT ^①
38	1 1/2	-38-MTA-1-24RT ^①

① Furnished with nut and preswaged ferrules.

Male

**ISO/BSP
Parallel
Thread (RS)**



1 in./25 mm and Under



Over 1 in./25 mm

Tube OD in.	ISO Thread Size in.	Basic Ordering Number
1/8	1/8	-2-TA-1-2RS
	1/4	-2-TA-1-4RS
1/4	1/8	-4-TA-1-2RS
	1/4	-4-TA-1-4RS
3/8	1/4	-6-TA-1-4RS
	3/8	-6-TA-1-6RS
1/2	1/4	-8-TA-1-4RS
	3/8	-8-TA-1-6RS
	1/2	-8-TA-1-8RS
3/4	3/4	-12-TA-1-12RS
1	1	-16-TA-1-16RS

Tube OD mm	ISO Thread Size in.	Basic Ordering Number
6	1/8	-6-MTA-1-2RS
	1/4	-6-MTA-1-4RS
8	1/4	-8-MTA-1-4RS
10	1/4	-10-MTA-1-4RS
	3/8	-10-MTA-1-6RS
	1/2	-10-MTA-1-8RS
12	1/4	-12-MTA-1-4RS
	3/8	-12-MTA-1-6RS
	1/2	-12-MTA-1-8RS
18	1/2	-18-MTA-1-8RS
	3/4	-18-MTA-1-12RS
28	1	-28-MTA-1-16RS ^①
	1 1/4	-28-MTA-1-20RS ^①
30	1 1/4	-30-MTA-1-20RS ^①
32	1 1/4	-32-MTA-1-20RS ^①
38	1 1/2	-38-MTA-1-24RS ^①

① Furnished with nut and preswaged ferrules.

Male

**ISO/BSP
Parallel
Thread (RP)**



Tube OD mm	ISO Thread Size in.	Basic Ordering Number
28	1 1 1/4	-28-MTA-1-16RP ^① -28-MTA-1-20RP ^①
30	1 1/4	-30-MTA-1-20RP ^①
32	1 1/4	-32-MTA-1-20RP ^①
38	1 1/2	-38-MTA-1-24RP ^①

① Furnished with nut and preswaged ferrules.

**SAE/MS
Straight
Thread (ST)**



1 in./25 mm and Under



Over 1 in./25 mm

Tube OD in.	SAE/MS Thread Size	Basic Ordering Number
1/8	5/16-24	-2-TA-1-2ST
1/4	7/16-20	-4-TA-1-4ST
3/8	7/16-20 9/16-18 3/4-16	-6-TA-1-4ST -6-TA-1-6ST -6-TA-1-8ST
1/2	9/16-18 3/4-16	-8-TA-1-6ST -8-TA-1-8ST
5/8	7/8-14	-10-TA-1-10ST
3/4	1 1/16-12	-12-TA-1-12ST
1	1 5/16-12	-16-TA-1-16ST
1 1/4	1 5/8-12	-20-TA-1-20ST ^①
1 1/2	1 7/8-12	-24-TA-1-24ST ^①
2	2 1/2-12	-32-TA-1-32ST ^①

① Furnished with nut and preswaged ferrules.

Male



**O-Seal
(SAE/MS
Straight
Thread)**

Tube OD in.	SAE/MS Thread Size	Basic Ordering Number
1/8	5/16-24	-2-TA-1-OR
3/16	3/8-24	-3-TA-1-OR
1/4	7/16-20	-4-TA-1-OR
5/16	1/2-20	-5-TA-1-OR
3/8	9/16-18	-6-TA-1-OR
1/2	3/4-16	-8-TA-1-OR

AN Thread



Tube OD in.	AN Tube Flare Size in.	Thread Size	Basic Ordering Number
1/4	1/4	7/16-20UNJF-3	-4-TA-1-4AN
3/8	1/4	7/16-20UNJF-3	-6-TA-1-4AN
	3/8	9/16-18UNJF-3	-6-TA-1-6AN
1/2	1/2	3/4-16UNJF-3	-8-TA-1-8AN
3/4	3/4	1 1/16-12UNJ-3	-12-TA-1-12AN
1	1	1 5/16-12UNJ-3	-16-TA-1-16AN



Pipe Weld

Tube OD in.	Pipe Weld Size in.	Basic Ordering Number
1/4	1/4	-4-TA-1-4W
3/8	1/2	-6-TA-1-8W
1/2	1/2	-8-TA-1-8W
	3/4	-8-TA-1-12W
3/4	3/4	-12-TA-1-12W

Female

NPT



1 in./25 mm and Under



Over 1 in./25 mm

Tube OD in.	NPT Size in.	Basic Ordering Number
1/8	1/8	-2-TA-7-2
	1/4	-2-TA-7-4
3/16	1/4	-3-TA-7-4
1/4	1/8	-4-TA-7-2
	1/4	-4-TA-7-4
	3/8	-4-TA-7-6
	1/2	-4-TA-7-8
5/16	1/4	-5-TA-7-4
3/8	1/8	-6-TA-7-2
	1/4	-6-TA-7-4
	3/8	-6-TA-7-6
	1/2	-6-TA-7-8
1/2	1/4	-8-TA-7-4
	3/8	-8-TA-7-6
	1/2	-8-TA-7-8
5/8	1/2	-10-TA-7-8
3/4	1/2	-12-TA-7-8
	3/4	-12-TA-7-12
	1	-12-TA-7-16
1	3/4	-16-TA-7-12
	1	-16-TA-7-16
1 1/4	1 1/4	-20-TA-7-20 ^①
1 1/2	1 1/2	-24-TA-7-24 ^①
2	2	-32-TA-7-32 ^①

① Furnished with nut and preswaged ferrules.

Tube OD mm	NPT Size in.	Basic Ordering Number
6	1/8	-6-MTA-7-2
	1/4	-6-MTA-7-4
8	1/4	-8-MTA-7-4
10	1/4	-10-MTA-7-4
	3/8	-10-MTA-7-6
	1/2	-10-MTA-7-8
12	1/4	-12-MTA-7-4
	1/2	-12-MTA-7-8

Female

**ISO/BSP
Tapered
Thread (RT)**



Tube OD in.	ISO Thread Size in.	Basic Ordering Number
1/4	1/8	-4-TA-7-2RT
	1/4	-4-TA-7-4RT
3/8	1/4	-6-TA-7-4RT
	3/8	-6-TA-7-6RT
1/2	1/4	-8-TA-7-4RT
	3/8	-8-TA-7-6RT
	1/2	-8-TA-7-8RT

Tube OD mm	ISO Thread Size in.	Basic Ordering Number
6	1/8	-6-MTA-7-2RT
8	1/4	-8-MTA-7-4RT
10	1/4	-10-MTA-7-4RT

**ISO/BSP
Parallel
Thread (RP)**

Tube OD in.	ISO Thread Size in.	Basic Ordering Number
1/8	1/8	-2-TA-7-2RP
1/4	1/8	-4-TA-7-2RP
	1/4	-4-TA-7-4RP
3/8	1/4	-6-TA-7-4RP
	3/8	-6-TA-7-6RP
1/2	3/8	-8-TA-7-6RP
	1/2	-8-TA-7-8RP

Tube OD mm	ISO Thread Size in.	Basic Ordering Number
6	1/8	-6-MTA-7-2RP
	1/4	-6-MTA-7-4RP
12	1/2	-12-MTA-7-8RP

Female



**ISO/BSP
Parallel
Thread
(RG, Gauge)**

Tube OD in.	ISO Thread Size in.	Basic Ordering Number
1/4	1/4	-4-TA-7-4RG
3/8	3/8	-6-TA-7-6RG
1/2	1/2	-8-TA-7-8RG

Tube OD mm	ISO Thread Size in.	Basic Ordering Number
6	1/4	-6-MTA-7-4RG
	3/8	-6-MTA-7-6RG
	1/2	-6-MTA-7-8RG
8	1/4	-8-MTA-7-4RG
	3/8	-8-MTA-7-6RG
	1/2	-8-MTA-7-8RG
10	1/4	-10-MTA-7-4RG
	3/8	-10-MTA-7-6RG
	1/2	-10-MTA-7-8RG
12	1/4	-12-MTA-7-4RG
	3/8	-12-MTA-7-6RG
	1/2	-12-MTA-7-8RG
16	1/2	-16-MTA-7-8RG
18	1/2	-18-MTA-7-8RG

Female



ISO/BSP Parallel Thread (RJ)

ISO/BSP parallel thread (RJ) fittings are available in stainless steel only.

Tube OD in.	ISO Thread Size in.	Ordering Number
1/4	1/4	SS-4-TA-7-4RJ
3/8	3/8	SS-6-TA-7-6RJ
1/2	1/2	SS-8-TA-7-8RJ

Tube OD mm	ISO Thread Size in.	Ordering Number
6	1/4	SS-6-MTA-7-4RJ
	3/8	SS-6-MTA-7-6RJ
	1/2	SS-6-MTA-7-8RJ
8	1/4	SS-8-MTA-7-4RJ
	3/8	SS-8-MTA-7-6RJ
	1/2	SS-8-MTA-7-8RJ
10	1/4	SS-10-MTA-7-4RJ
	3/8	SS-10-MTA-7-6RJ
	1/2	SS-10-MTA-7-8RJ
12	1/4	SS-12-MTA-7-4RJ
	3/8	SS-12-MTA-7-6RJ
	1/2	SS-12-MTA-7-8RJ



AN Thread

Tube OD in.	AN Tube Flare Size in.	Basic Ordering Number
1/8	1/8	-200-A-2ANF
	1/4	-200-A-4ANF
1/4	1/4	-400-A-4ANF
3/8	3/8	-600-A-6ANF
1/2	1/2	-810-A-8ANF
3/4	3/4	-1210-A-12ANF

Tube Fitting Part Numbers

Swagelok tube fitting part numbers follow the sequence shown below.

A - **B** **C** **D** - **E** - **F** **G**
SS - **2** **0** **0** - **1** - **2** **RT**

A Material

- A** = Aluminum
- B** = Brass
- C20** = Alloy 20
- HC** = Alloy C-276
- INC** = Alloy 600
- M** = Alloy 400
- NY** = Nylon
- S** = Carbon steel
- SS** = 316 stainless steel
- T** = PTFE
- TI** = Titanium
- 625** = Alloy 625
- 825** = Alloy 825

B Size (Tube OD)

Fractional, in.	Metric, mm
1 = 1/16	2 = 2
2 = 1/8	3 = 3
3 = 3/16	4 = 4
4 = 1/4	6 = 6
5 = 5/16	8 = 8
6 = 3/8	10 = 10
8 = 1/2	12 = 12
10 = 5/8	14 = 14
12 = 3/4	15 = 15
14 = 7/8	16 = 16
16 = 1	18 = 18
18 = 1 1/8	20 = 20
20 = 1 1/4	22 = 22
24 = 1 1/2	25 = 25
32 = 2	28 = 28
	32 = 32
	38 = 38
	50 = 50

A - **B** **C** **D** - **E** - **F** **G**
SS - **2** **0** **0** - **1** - **2** **RT**

C Series

0 = Fractional 1/16 to 3/8 in.
 and 1 1/4 to 2 in.

1 = Fractional 1/2 to 1 1/8 in.

M = Millimeter tube size

To order a female Swagelok tube fitting, add **F**.

Example: SS-100**F**-1-1.

D Component

0 = Fitting

1 = Body

E Fitting Type

1 = Male connector

2 = 90° male elbow

3 = Tee, union

4 = Cross, union

5 = 45° male elbow

6 = Union

7 = Female connector

8 = Female elbow

9 = Elbow, union

11 = Bulkhead male connector

61 = Bulkhead union

71 = Bulkhead female connector

A = Adapter

C = Cap

P = Plug

PC = Port connector

R = Reducer

R1 = Bulkhead reducer

2R = Reducing elbow

TFT = Tee, female run

TMT = Tee, male run

TRT = Tee, ISO/BSP parallel
 male positionable run

TST = Tee, straight thread with O-ring
 male positionable run

TTF = Tee, female branch

TTM = Tee, male branch

TTR = Tee, ISO/BSP parallel
 male positionable branch

TTS = Tee, straight thread with O-ring
 male positionable branch

A - **B** **C** **D** - **E** - **F** **G**
SS - **2** **0** **0** - **1** - **2** **RT**

F Second End Connection Size

Add a size designator from the list on page 99 for the second end connection *or* if the fitting is a reducing union.

G Second End Connection Type

Add a second end connection type designator as needed.

AN = 37° male AN flare

ANF = 37° female AN flare

BT = Bored-through fitting

F = Female thread

KN = Knurled nut, nylon ferrules

KT = Knurled nut, PTFE ferrules

M = Metric tube end

OR = O-seal connection

PR = ISO/BSP positionable parallel pipe thread

RG = ISO/BSP parallel pipe thread (gauge)

RJ = ISO/BSP parallel pipe thread
(Japanese gauge)

RP = ISO/BSP parallel pipe thread

RS = ISO/BSP parallel pipe thread

RT = ISO/BSP tapered pipe thread

ST = Straight thread with O-ring (for SAE/MS)

W = Male pipe weld/tube socket weld

Tees and Crosses

Ordering numbers for tees and crosses indicate first the size of the run (**1** to **2**) and then the size of the branch (**3** for tees and **3** to **4** for crosses).

Example: SS-6M0-3-4TTF for a
 316 SS female tee for
 6 mm tube with 1/4 in.
 female NPT branch

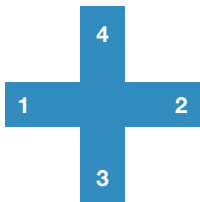

Tube Adapter Part Numbers

Swagelok tube adapter part numbers follow the sequence shown below.

A - **B** - **C** - **D** - **E** **F**
SS - **2** - **TA** - **1** - **4** **RT**

A Material

- A** = Aluminum
- B** = Brass
- C20** = Alloy 20
- HC** = Alloy C-276
- INC** = Alloy 600
- M** = Alloy 400
- NY** = Nylon
- S** = Steel
- SS** = Stainless steel
- T** = PTFE
- TI** = Titanium
- 625** = Alloy 625
- 825** = Alloy 825

B Size (Tube OD)

Fractional, in.	Metric, mm
1 = 1/16	2 = 2
2 = 1/8	3 = 3
3 = 3/16	4 = 4
4 = 1/4	6 = 6
5 = 5/16	8 = 8
6 = 3/8	10 = 10
8 = 1/2	12 = 12
10 = 5/8	14 = 14
12 = 3/4	15 = 15
14 = 7/8	16 = 16
16 = 1	18 = 18
18 = 1 1/8	20 = 20
20 = 1 1/4	22 = 22
24 = 1 1/2	25 = 25
32 = 2	28 = 28
	32 = 32
	38 = 38
	50 = 50

A - **B** - **C** - **D** - **E** **F**
SS - **2** - **TA** - **1** - **4** **RT**

C Component

TA = Fractional tube adapter

MTA = Metric tube adapter

D Adapter Type

1 = Male adapter

7 = Female adapter

E Second End Connection Size

Add a size designator from the list on page 102 for the second end connection.

F Second End Connection Type

Add a second end connection type designator as needed.

AN = 37° male AN flare

ANF = 37° female AN flare

RG = ISO/BSP parallel pipe thread (gauge)

RJ = ISO/BSP parallel pipe thread
(Japanese gauge)

RP = ISO/BSP parallel pipe thread

RS = ISO/BSP parallel pipe thread

RT = ISO/BSP tapered pipe thread

ST = Straight thread with O-ring (for SAE/MS)

W = Male pipe weld/tube socket weld

Nuts**Female**

Tube OD in.	Basic Ordering Number
1/16	-102-1
1/8	-202-1
3/16	-302-1
1/4	-402-1
5/16	-502-1
3/8	-602-1
1/2	-812-1
5/8	-1012-1
3/4	-1212-1
7/8	-1412-1
1	-1612-1
1 1/4	-2002-1
1 1/2	-2402-1
2	-3202-1

Tube OD mm	Basic Ordering Number
2	-2M2-1
3	-3M2-1
4	-4M2-1
6	-6M2-1
8	-8M2-1
10	-10M2-1
12	-12M2-1
14	-14M2-1
15	-15M2-1
16	-16M2-1
18	-18M2-1
20	-20M2-1
22	-22M2-1
25	-25M2-1
28	-28M2-1
30	-30M2-1
32	-32M2-1
38	-38M2-1
50	-50M2-1

Nuts



Knurled Female

The Swagelok knurled nut tube fitting provides a leak-tight seal without the use of inserts on most wall thicknesses of polyethylene tubing. Inserts may be required for larger sizes.

To set the ferrules on the tubing, initial connections must be made with a wrench, tightening the nut one and one-quarter turns from finger-tight (three-quarters turn for 1/16, 1/8 and 3/16 in.; 2, 3, and 4 mm fittings). Leak-tight connections may be reassembled with finger-tight assembly.

To order a knurled nut, add **K** to the female nut basic ordering number.

Example: B-402-1**K**

To order a knurled nut on an assembled fitting with nylon ferrules, add **KN** to the fitting ordering number.

Example: SS-400-1-2**KN**

To order a knurled nut on an assembled fitting with PTFE ferrules, add **KT** to the fitting ordering number.

Example: SS-400-1-2**KT**

Male

For use in female Swagelok end connections.



Tube OD in,	Basic Ordering Number
1/16	-1F2-1GC
1/8	-2F2-1GC
1/4	-4F2-1
1/2	-8F2-1

Tube OD mm	Basic Ordering Number
10	-10MF2-1
12	-12MF2-1

Ferrules



Front

Tube OD in.	Basic Ordering Number
1/16	-103-1
1/8	-203-1
3/16	-303-1
1/4	-403-1
5/16	-503-1
3/8	-603-1
1/2	-813-1
5/8	-1013-1
3/4	-1213-1
7/8	-1413-1
1	-1613-1
1 1/4	-2003-1 ^①
1 1/2	-2403-1 ^①
2	-3203-1 ^①

Tube OD mm	Basic Ordering Number
2	-2M3-1
3	-3M3-1
4	-4M3-1
6	-6M3-1
8	-8M3-1
10	-10M3-1
12	-12M3-1
14	-14M3-1
15	-15M3-1
16	-16M3-1
18	-18M3-1
20	-20M3-1
22	-22M3-1
25	-25M3-1
28	-28M3-1 ^①
30	-30M3-1 ^①
32	-32M3-1 ^①
38	-38M3-1 ^①
50	-50M3-1 ^①

① Over 1 in. and over 25 mm stainless steel front ferrules are PFA coated. To order silver-plated front ferrules, add **-BL** to the basic ordering number.

Example:
SS-2003-1-**BL**

Ferrules



Back

Tube OD in.	Basic Ordering Number
1/16	-104-1
1/8	-204-1
3/16	-304-1
1/4	-404-1
5/16	-504-1
3/8	-604-1
1/2	-814-1
5/8	-1014-1
3/4	-1214-1
7/8	-1414-1
1	-1614-1
1 1/4	-2004-1 ^①
1 1/2	-2404-1 ^①
2	-3204-1 ^①

Tube OD mm	Basic Ordering Number
2	-2M4-1
3	-3M4-1
4	-4M4-1
6	-6M4-1
8	-8M4-1
10	-10M4-1
12	-12M4-1
14	-14M4-1
15	-15M4-1
16	-16M4-1
18	-18M4-1
20	-20M4-1
22	-22M4-1
25	-25M4-1
28	-28M4-1 ^①
30	-30M4-1 ^①
32	-32M4-1 ^①
38	-38M4-1 ^①
50	-50M4-1 ^①

① Over 1 in. and over 25 mm stainless steel back ferrules are PFA coated. To order back ferrules without PFA coating, add **-WC** to the basic ordering number.

Example:
SS-2004-1-**WC**

Nut-Ferrule Sets and Nut-Ferrule Packages

Nut-Ferrule Set

The nut-ferrule set contains one nut, one back ferrule, and one front ferrule.

To order, add a material designator to the basic ordering number. Please order nut-ferrule sets in multiples of five.

Example: **SS-400-NFSET**

Material	Designator
Brass	B
Carbon steel	S
316 stainless steel	SS

Tube OD in.	Basic Ordering Number
1/4	-400-NFSET
3/8	-600-NFSET
1/2	-810-NFSET

Tube OD mm	Basic Ordering Number
6	-6M0-NFSET
8	-8M0-NFSET
10	-10M0-NFSET
12	-12M0-NFSET

Nut-Ferrule Package

To order the nut-ferrule package (50 nut-ferrule sets), contact your authorized Swagelok representative.



Ferrule Sets and Ferrule-Paks

Ferrule Set

The ferrule set contains one front ferrule and one back ferrule.

To order, add a material designator to the basic ordering number. Please order ferrule sets in multiples of ten.

Example: **SS-100-SET**

Material	Designator
Alloy 400	M
Aluminum	A
Brass	B
Carbon steel	S
Nylon	NY
PTFE	T
316 stainless steel	SS

Tube OD in.	Basic Ordering Number
1/16	-100-SET
1/8	-200-SET
3/16	-300-SET
1/4	-400-SET
5/16	-500-SET
3/8	-600-SET
1/2	-810-SET

Tube OD mm	Basic Ordering Number
6	-6M0-SET
8	-8M0-SET
10	-10M0-SET
12	-12M0-SET

Ferrule-Pak

To order the ferrule-pak package (100 front and back sets), contact your authorized Swagelok representative.

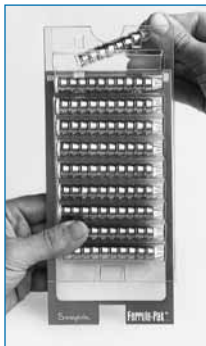

ISO/BSP Parallel Gaskets



**RS/RSD
Gasket**



**RSNB
Gasket**

Steel and Stainless Steel (RS Fitting)

RS fitting steel gaskets provide a seal with male ISO/BSP parallel threads.

The RS gasket is of a fluorocarbon FKM inner ring bonded to a carbon steel outer ring.

The RSD (DIN-style) gasket is a fluorocarbon FKM inner ring bonded to a stainless steel or carbon steel outer ring as recommended in ISO 1179-1973. It can be used with end connections designed in accordance with DIN 3852 Part 2.

The RSNB gasket is an all-metal 304L stainless steel gasket similar to DIN 7603 form D.

ISO Thread Size, in.	Ordering Number		
	RS Gasket ^①	RSD Gasket ^②	RSNB Gasket
1/8	S-2-RS-2V	SS-2-RSD-2V	304L-2-RSNB-2
1/4	S-4-RS-2V ^③	SS-4-RSD-2V	304L-4-RSNB-2
3/8	S-6-RS-2V ^③	SS-6-RSD-2V	304L-6-RSNB-2
1/2	S-8-RS-2V ^③	SS-8-RSD-2V	304L-8-RSNB-2
3/4	S-12-RS-2V	SS-12-RSD-2V	304L-12-RSNB-2
1	S-16-RS-2V	SS-16-RSD-2V	304L-16-RSNB-2
1 1/4	S-20-RS-2V	SS-20-RSD-2V	304L-20-RSNB-2
1 1/2	S-24-RS-2V	SS-24-RSD-2V	304L-24-RSNB-2

① Also available with a Buna inner ring. To order, replace **V** with **B** in the ordering number.

Example: S-2-RS-2**B**

② Also available with a carbon steel outer ring. To order, replace **SS** with **S** in the ordering number.

Example: **S**-8-RSD-2V

③ Also available with a stainless steel outer ring. To order, replace **S** with **SS** in the ordering number.

Example: **SS**-8-RS-2V

ISO/BSP Parallel Gaskets



Copper (RP and RS Fitting)

The RP and RS fitting copper gasket provides a seal with male ISO/BSP parallel threads.

ISO Thread Size, in.	Ordering Number
1/8	CU-2-RP-2
1/4	CU-4-RP-2
3/8	CU-6-RP-2
1/2	CU-8-RP-2
3/4	CU-12-RP-2
1	CU-16-RP-2
1 1/4	CU-20-RP-2
1 1/2	CU-24-RP-2



Copper and Nickel (RG, Gauge Fitting)

The RG fitting gasket provides a seal on pressure gauges equipped with ISO/BSP parallel male threads.

ISO Thread Size, in.	Ordering Number
Copper Gaskets	
1/4	CU-4-RG-2
3/8	CU-6-RG-2
1/2	CU-8-RG-2
Nickel Gaskets	
1/4	NI-4-RG-2
3/8	NI-6-RG-2
1/2	NI-8-RG-2



PTFE (RJ Fitting)

The RJ fitting PTFE gasket provides a seal with ISO/BSP parallel male threads.

ISO Thread Size, in.	Ordering Number
Regular Gaskets	
1/4	T-4-RJ-2
3/8	T-6-RJ-2
1/2	T-8-RJ-2
Thick Gaskets	
1/4	T-4-RJ-2-T
3/8	T-6-RJ-2-T
1/2	T-8-RJ-2-T

O-Rings

Buna N (O-Seal Straight Threads)

O-ring
hardness is 70
durometer.

Thread Size in.	Uniform Size Number	Ordering Number
5/16-24	011	BN-70-OR-011
3/8-24	012	BN-70-OR-012
7/16-20	013	BN-70-OR-013
1/2-20	112	BN-70-OR-112
9/16-18	113	BN-70-OR-113
3/4-16	116	BN-70-OR-116
1 1/16-12	121	BN-70-OR-121
1 5/16-12	125	BN-70-OR-125

Buna N (O-Seal Pipe Threads)

O-ring
hardness is 70
durometer.

NPT/ISO Pipe Size in.	Uniform Size Number	Ordering Number
1/8	013	BN-70-OR-013
1/4	113	BN-70-OR-113
3/8	116	BN-70-OR-116
1/2	118	BN-70-OR-118

O-Rings

**Fluorocarbon
FKM
(Positionable
Fittings,
ISO/BSP
Parallel
Threads)**

O-ring hardness
is 90 durometer.

ISO Thread Size in.	Uniform Size Number	Ordering Number
1/8	502 ^①	FSP-90-OR-502
1/4	111	FCBR-90-OR-111
3/8	113	FCBR-90-OR-113
1/2	508 ^①	FCBR-90-OR-508
3/4	119	FCBR-90-OR-119
1	217	FCBR-90-OR-217

① Not a uniform O-ring size.

**Fluorocarbon
FKM
(SAE/MS
Straight
Threads)**

O-ring hardness
is 90 durometer.

SAE/MS Thread Size	Uniform Size Number	Ordering Number
5/16-24	902	FCBR-90-OR-902
3/8-24	903	FCBR-90-OR-903
7/16-20	904	FCBR-90-OR-904
1/2-20	905	FCBR-90-OR-905
9/16-18	906	FCBR-90-OR-906
3/4-16	908	FCBR-90-OR-908
7/8-14	910	FCBR-90-OR-910
1 1/16-12	912	FCBR-90-OR-912
1 3/16-12	914	FCBR-90-OR-914
1 5/16-12	916	FCBR-90-OR-916
1 5/8-12	920	FCBR-90-OR-920
1 7/8-12	924	FCBR-90-OR-924
2 1/2-12	932	FCBR-90-OR-932

Bulkhead Retainers

The bulkhead retainer acts as a backup wrench, enabling one person with one wrench to install a bulkhead fitting.



Fitting Size		Ordering Number
in.	mm	
1/16	—	SS-102-61F
1/8	—	SS-202-61F
3/16	3, 4	SS-302-61F
1/4	6	SS-402-61F
5/16	—	SS-502-61F
—	8	SS-8M2-61F
3/8	—	SS-602-61F
—	10	SS-10M2-61F
1/2	12	SS-812-61F
5/8	15, 16	SS-1012-61F
3/4	18	SS-1212-61F
7/8	—	SS-1412-61F
1	—	SS-1612-61F

Gap Inspection Gauges



Swagelok gap inspection gauges assure the installer or inspector that the fitting has been sufficiently pulled up on initial installation, whether using a multihead hydraulic swaging unit (MHSU) or air-actuated hydraulic swaging unit (AHSU), or wrench tightening. All metal Swagelok tube fittings are gaugeable, with the exception of a few forged bodies in aluminum.

For Installation Using a Wrench

Fitting Size		Ordering Number
in.	mm	
Female Nut		
1/16	—	MS-IG-100
1/8	2, 3	MS-IG-200
3/16	4	MS-IG-300
1/4	6	MS-IG-400
1/4, 3/8, 1/2	6, 12	MS-IG-468
1/4, 1/2	6, 8, 10, 12	MS-IG-612M
5/16	8	MS-IG-500
3/8	—	MS-IG-600
—	10	MS-IG-10M0
1/2	12	MS-IG-810
5/8	14, 15, 16	MS-IG-1010
5/8 (SAF 2507)	—	MS-IG-2507-1010
3/4	18	MS-IG-1210
3/4 (SAF 2507)	—	MS-IG-2507-1210
7/8	20, 22	MS-IG-1410
1	25	MS-IG-1610
Male Nut		
1/16	—	MS-IG-1F0
1/8	2, 3	MS-IG-2F0
1/4, 3/8, 1/2 (medium-pressure)	—	MS-IG-FK0

Gap Inspection Gauges

For Installation Using the AHSU

Fitting Size		Ordering Number
in.	mm	
Female Nut		
1/4, 3/8, 1/2	—	MS-AHSU-IG-468
—	6, 8, 10, 12	MS-AHSU-IG-612M

For Installation Using the MHSU

Fitting Size		Ordering Number
in.	mm	
Female Nut		
1/2 ^①	12	MS-MHSU-IG-810
5/8 ^②	14, 15, 16	MS-MHSU-IG-1010
5/8 (SAF 2507)	—	MS-MHSU-IG-2507-1010
3/4 ^②	18	MS-MHSU-IG-1210
3/4 (SAF 2507)	—	MS-MHSU-IG-2507-1210
7/8	20, 22	MS-MHSU-IG-1410
1	25	MS-MHSU-IG-1610-1
—	28	MS-MHSU-IG-28M0-1
	30	MS-MHSU-IG-30M0-1
1 1/4	—	MS-MHSU-IG-2000-2
—	32	MS-MHSU-IG-32M0-1
—	38	MS-MHSU-IG-38M0-1
1 1/2	—	MS-MHSU-IG-2400-1
—	50	MS-MHSU-IG-50M0-1
2	—	MS-MHSU-IG-3200-1

① The MHSU cannot be used for SAF 2507 tubing 1/2 in. and under or for medium-pressure tubing.

② For 5/8 and 3/4 in. SAF 2507 tubing, order the 1 in. (25 mm) and over unit and SAF 2507 tooling and gauge.

Depth Marking Tools



Swagelok depth marking tools help ensure that tubing is bottomed on the shoulder inside the Swagelok tube fitting body.

Tube OD in.	Ordering Number
1/4	MS-DMT-400
3/8	MS-DMT-600
1/2	MS-DMT-810
5/8	MS-DMT-1010
3/4	MS-DMT-1210
7/8	MS-DMT-1410
1	MS-DMT-1610

Tube OD mm	Ordering Number
6	MS-DMT-6M0
8	MS-DMT-8M0
10	MS-DMT-10M0
12	MS-DMT-12M0
16	MS-DMT-16M0
18	MS-DMT-18M0

Preswaging Tools

For Swagelok tube fitting installations in close quarters, the Swagelok preswaging tool is a convenient accessory.



Tube OD in.	Ordering Number
Female Nut	
1/16	MS-ST-100
1/8	MS-ST-200
3/16	MS-ST-300
1/4	MS-ST-400
5/16	MS-ST-500
3/8	MS-ST-600
1/2	MS-ST-810
5/8	MS-ST-1010
5/8 (SAF 2507)	MS-ST-2507-1010
3/4	MS-ST-1210
3/4 (SAF 2507)	MS-ST-2507-1210
7/8	MS-ST-1410
1	MS-ST-1610
Male Nut	
1/16	MS-ST-1F0
1/4 (medium-pressure)	MS-ST-4FK0
3/8 (medium-pressure)	MS-ST-6FK0
1/2	MS-ST-8F0
1/2 (medium-pressure)	MS-ST-8FK0

Tube OD mm	Ordering Number
Female Nut	
3	MS-ST-3M0
4	MS-ST-4M0
6	MS-ST-6M0
8	MS-ST-8M0
10	MS-ST-10M0
12	MS-ST-12M0
14	MS-ST-14M0
15	MS-ST-15M0
16	MS-ST-16M0
18	MS-ST-18M0
20	MS-ST-20M0
22	MS-ST-22M0
25	MS-ST-25M0

Inserts for Soft Plastic Tubing

Swagelok inserts help secure soft plastic tubing being used with standard Swagelok tube fittings. To



determine the correct size of the Swagelok insert to be used, check both outside diameter and inside diameter of the plastic tubing.

Add the insert material designator to the basic ordering number.

Example:
B-305-2

Material	Designator
Alloy 400	M
Aluminum	A
Brass	B
Carbon steel	S
Nylon	NY
Stainless steel	SS

Tube OD in.	Tube ID in.	Bore ID in.	Basic Ordering Number
3/16	1/8	0.09	-305-2
1/4	1/8	0.09	-405-2
	0.17	0.11	-405-170
	3/16	0.14	-405-3
5/16	1/8	0.09	-505-2
	3/16	0.12	-505-3
	1/4	0.19	-505-4
3/8	3/16	0.12	-605-3
	1/4	0.19	-605-4
1/2	1/4	0.19	-815-4
	3/8	0.31	-815-6
5/8	3/8	0.31	-1015-6
	1/2	0.44	-1015-8
3/4	1/2	0.44	-1215-8
	5/8	0.56	-1215-10
1	3/4	0.69	-1615-12

Tube OD mm	Tube ID mm	Bore ID mm	Basic Ordering Number
6	4	2.8	-6M5-4M
8	6	4.4	-8M5-6M
10	8	6.4	-10M5-8M
12	8	6.4	-12M5-8M
	10	8.3	-12M5-10M

For product technical data, see the Swagelok *Gaugeable Tube Fittings and Adapters* catalog, MS-01-140.

Safe Product Selection

When selecting a product, the total system design must be considered to ensure safe, trouble-free performance. Function, material compatibility, adequate ratings, proper installation, operation, and maintenance are the responsibilities of the system designer and user. The complete catalog contents must be reviewed to ensure that the system designer and user make a safe product selection.

Caution: Do not mix or interchange components with those of other manufacturers.

Warranty Information

Swagelok products are backed by The Swagelok Limited Lifetime Warranty. For a copy, visit swagelok.com or contact your authorized Swagelok representative.

Swagelok, Ferrule-Pak, Goop, Swak—
TM Swagelok Company
SAF 2507—TM Sandvik AB
© 2006–2014 Swagelok Company
Printed in U.S.A., AGS
April 2014, R9
MS-13-151