

Pressure and Temperature Transducer (PTX)



User's Manual

This manual contains important information for the safe and effective operation of the Swagelok® Pressure and Temperature Transducer, PTX series. Users should read and understand its contents before operating the transducer.

Contents

Introduction	3
Product Information	3
Specifications	4
Control Drawing	5
Installation	6
Mounting	6
Power Supply.	7
DeviceNet™ Network Cable	7
Setup	8
Node Setup.	8
Parameter Setup	9
Operation	13
Zero Compensation	13
Poll Request	14
Maintenance	14
Troubleshooting	15
Glossary	16

Introduction

The Swagelok Pressure and Temperature Transducer (PTX) is an industrial pressure and temperature transducer for monitoring fluid pressure and temperature in automated fluid systems using a MEMS pressure-sensing technology. It communicates pressure and temperature data via the DeviceNet industrial network protocol. The PTX is available with a 1.5 in. Swagelok Modular Platform Component (MPC) surface mount in accordance with ANSI/ISA 76.00.02 or with 1/4 in. Swagelok tube fitting connections.

Product Information



Fig. 1 PTX with MPC Modular Surface Mount front view



Fig. 2 PTX with 1/4 in. Swagelok Tube Fitting End Connections

Specifications

Power		
Voltage	24 V (dc), nominal	
Current	< 100 mA (dc) at 24 V (dc)	
Wattage	< 2.4 W at 24 V (dc)	
Temperature (environment)		
Operating (Ambient)	Minimum	23°F (-5°C)
	Maximum	158°F (70°C)
Media	Minimum	32°F (0°C)
	Maximum	158°F (70°C)
Storage	Minimum	-40°F (-40°C)
	Maximum	158°F (70°C)
Temperature Measurement	Measurement Range	23 to 158°F (-5 to 70°C)
	Accuracy, including: Repeatability Hysteresis Nonlinearity	± 2.2°C absolute accuracy
Full-scale Range	0 to 50 psig (0 to 3.4 bar)	
	0 to 250 psig (0 to 17.2 bar)	
	0 to 500 psig (0 to 34.4 bar)	
Pressure Measurement	Accuracy at 77°F (25°C) including: Repeatability Hysteresis Nonlinearity	± 1 % of full scale pressure, following steps in accordance with setup procedures described in this manual
Over Pressure	2 × full scale	
Burst Pressure	5 × full scale	
Weight	with MPC process connections	0.83 lb (375 g)
	with 1/4 in. Swagelok tube fitting connections	1.26 lb (570 g)
Certifications	<ul style="list-style-type: none"> ■ ANSI/ISA 12.12.01-2011 Non-incendive Electrical Equipment for use in Class I, Division 2 Hazardous Locations ■ UL 61010-1, Safety Requirements for Electrical Equipment for Measurement, Control, and Laboratory Use—Part 1, Edition 2 ■ CSA C22.2 No. 213-M1987, Non-incendive Control Equipment for use in Class I, Division 2 Hazardous Locations ■ CSA C22.2 No 61010-1, Safety Requirements for Electrical Equipment for Measurement, Control, and Laboratory Use—Part 1, Edition 2 	
Ingress Protection	IP64	
Electromagnetic Compatibility	EN 61326-1:2006 <ul style="list-style-type: none"> ■ RF Emissions: EN 55011 ■ ESD Immunity: EN 61000-4-2 ■ RF Immunity: EN 61000-4-3 ■ EFT Immunity: EN61000-4-4 ■ Conducted Immunity: EN 61000-4-6 	
Vibration	Sinusoidal 9 to 200 Hz, 5 g acceleration	
	Random 20 to 500 Hz, 15.5 g average acceleration	
Shock	Pulse 70 m/s ² (7.2 g)	
Entity Parameters	See Control Drawing: PTX-DN-0006-SCHEDULE	
Supported Communication Baud Rates	Auto-baud function, allowing the device to detect the speed of network traffic. It is compatible with 125 kbaud, 250 kbaud, and 500 kbaud rates.	

Note: Before installing the PTX in a hazardous location, review the control drawing on page 5. This will help ensure all electrical connections to and from the PTX comply with safety requirements.

Control Drawing

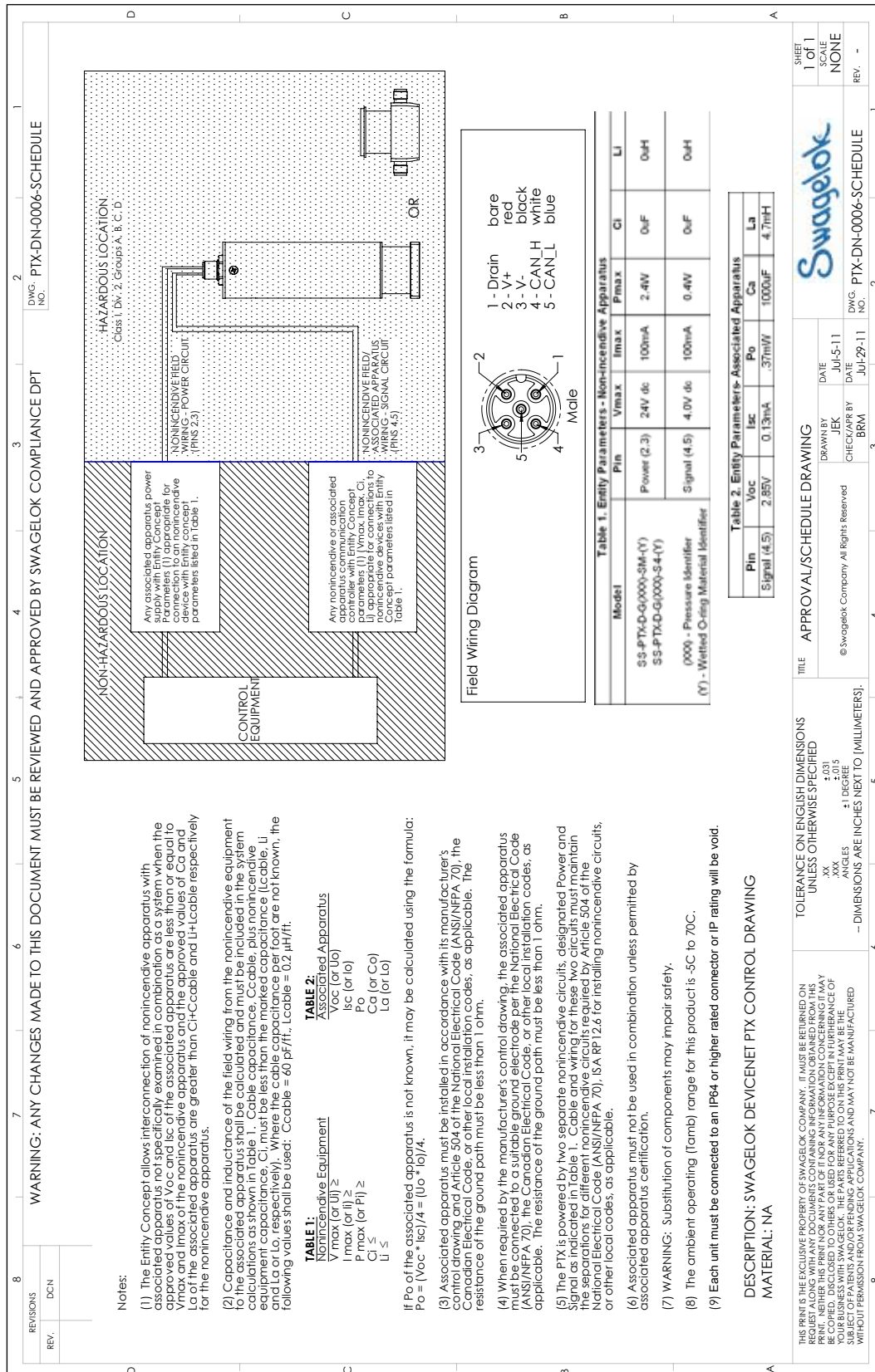

Fig. 3 PTX-DN-0006 SCHEDULE

Installation

Mounting

A PTX with 1/4 in. Swagelok tube fitting process end connections should be installed in the system according to *Swagelok Tube Fitting Instructions for 1 in. (25 mm) and smaller fittings*, MS-12-01.

A PTX with a 1.5 in. Swagelok MPC modular surface mount should be installed in the system according to the surface mount assembly instructions in the *MPC Series Modular Platform Components Assembly and Service Instructions*, MS-12-39.

Dimensions, in inches (millimeters), are for reference only and subject to change.

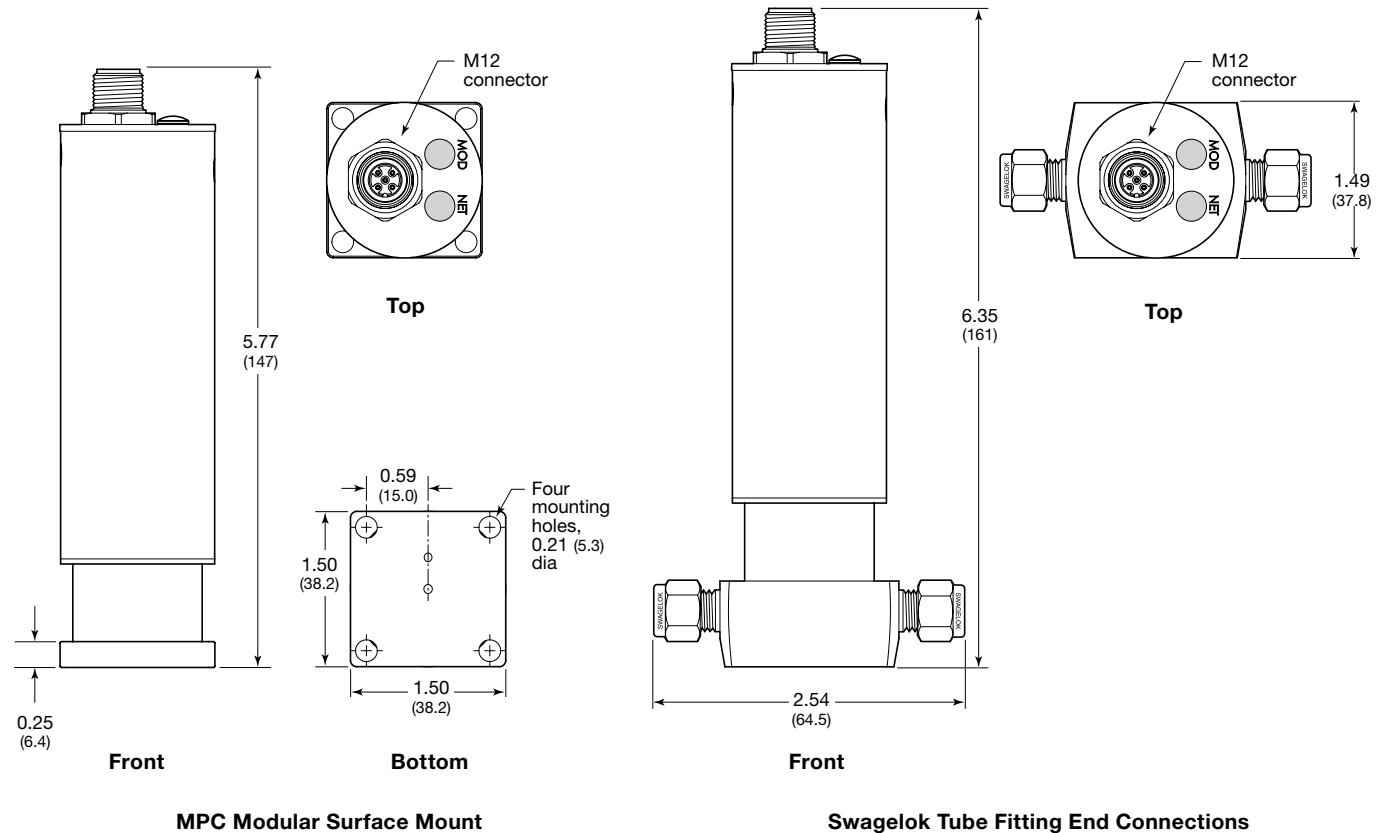

Fig. 4 Product Dimensions

Power Supply

The PTX requires voltage supplied to be within the range of the DeviceNet standard, which states: 24 volts $\pm 1\%$ or adjustable to 0.2%. Use of a lower voltage network power supply will decrease the reliability of the network and may make it inoperable. Swagelok validated the performance of the PTX operating at 11, 24, and 28 V (dc).

Hazardous Location Power Supply

It is required that a Class 2 power supply be used when the PTX is used in Class I, Division 2 hazardous locations. Class 2 power supplies have a maximum power outlet of 100 W.

DeviceNet Network Cable

Cable Length

DeviceNet network cable lengths are defined in ODVA's *Planning and Installation Manual: DeviceNet Cable System*, chapter 1, www.odva.org. Using cable lengths longer than those recommended can result in degradation of signal integrity and decrease of supply voltage.

Hazardous Location Cable Length

The power supply used determines the maximum capacitance and inductance for the network. The total network inductance and capacitance can be determined by adding together the inductance and capacitance values of the devices on the network along with that of the cable.

The Swagelok PTX adds 0 μ H and 0 μ F to the network.

Cable parameters can be determined from the manufacturer's data sheet. Worst case values of 60 pF/ft and 0.2 μ H/ft can be assumed when that information is not available.

Cable Bend Radius

The DeviceNet network cable should not be bent too tightly, as this causes excess strain on the cable and the attachment point on the device. After the cable has been installed, the bend radius can be adjusted so long as it is no smaller than its fixed radius. Typical cables and their bend radii can be found in ODVA's *Planning and Installation Manual: DeviceNet Cable System*, chapter 1.

Connecting the Cable

Connect the micro M12 connector end of the network cable to the network interface plug on the PTX. Connect the opposite end to the system network.

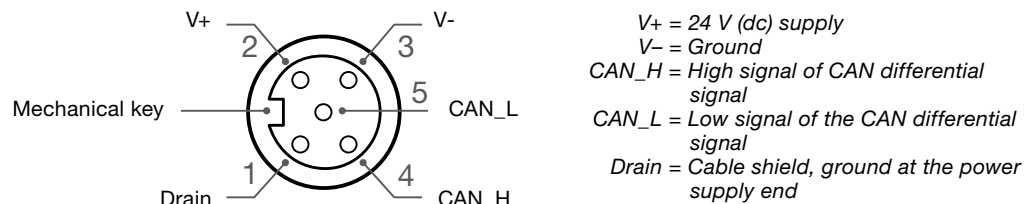

Fig. 5 M12 Female Connector End

Setup

Node Setup

Register the Electronic Data Sheet (EDS)

1. Download the electronic data sheet (EDS) and the icon file (PTX.ico) from **www.swagelok.com**. (*path TBD*) Save both files to the same directory.
Note: Altering the EDS in any way voids the product warranty.
2. Open your network configuration tool. The screen captures in this manual use RSNNetWorx™ for DeviceNet. Alternatives include OMRON® DeviceNet Configurator and Anybus® NetTool.
3. Register the EDS using the network configuration tool.
4. Connect the PTX to the network.
5. Scan the network for the PTX and once found, open the properties interface for the device.
6. Set the device address (MAC ID) of the device to the desired value.

Device Address (MAC ID)

The PTX will have a factory set address of 63 when initially powered on. Addresses between 0 and 63 are valid DeviceNet addresses. Do not duplicate addresses. Duplicate addresses will cause the devices at that address to be unable to communicate with the network. As noted, new devices will be set to address 63, so it is recommended to leave that address open to accommodate new hardware.

Assign higher priority devices a low network address as the lowest network address will be given priority during network arbitration.

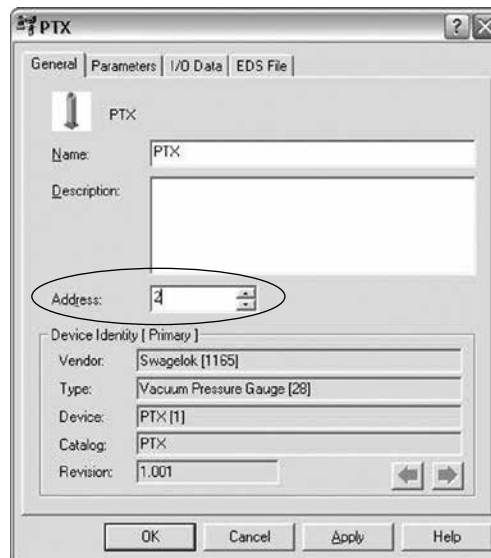

Fig. 6 General Tab

Parameter Setup

Open the parameters menu after the device is recognized by the configuration software. Set the parameters that follow as desired for use with your network.

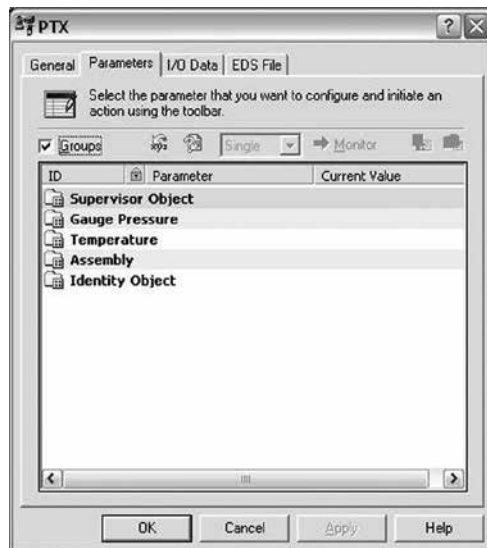

Fig. 7 Parameters Tab

Message Format

The PTX supports several message formats as defined below. Each message format contains different information and results in a different amount of network traffic. The truncated integer values use fewer bytes to encode, resulting in less network traffic.

Name	I/O Type*	Bytes	Format
Status, Pressure, Temperature (REAL) (factory default)	Polled Input	9	Status Byte (See Operation) Pressure (Real) Temperature (Real)
Status, Pressure (REAL)	Polled Input	5	Status Byte (See Operation) Pressure (Real)
Status, Pressure, Temperature (Integer)	Polled Input	5	Status Byte (See Operation) Pressure (Integer) Temperature (Integer)
Status, Pressure (Integer)	Polled Input	3	Status Byte (See Operation) Pressure (Integer)
Alert Reset	Polled Output	1	Reset Byte

Note: Input and output are defined from the standpoint of the DeviceNet network.

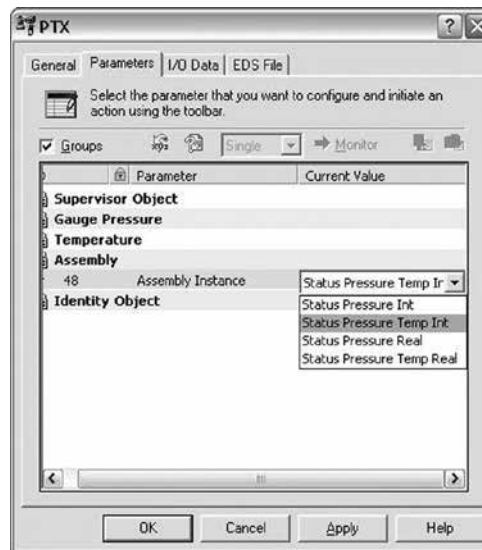

Fig. 8 Setting Message Format

Set Units

The PTX can report the pressure and temperature values to the network in a variety of units.

Pressure Units	Temperature Units
psig (factory default)	°F (factory default)
bar	°C
kPa	% full scale
% full scale	

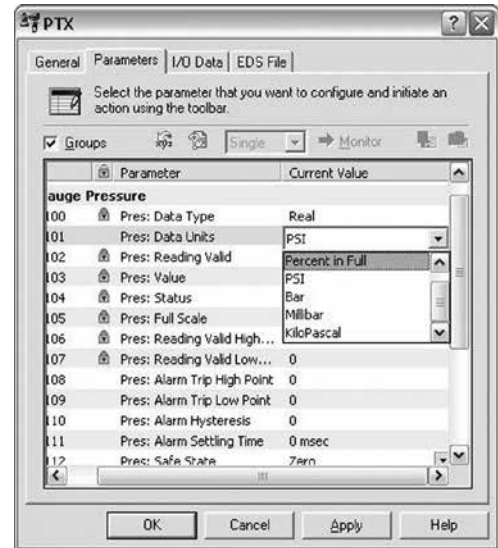

Fig. 9 Set Units

Set Alarms

The PTX can be set to send an alarm when the pressure or temperature falls below, or rises above, a certain value. Additionally, alarm hysteresis and settling time can be set.

Note: The units for the alarms will be the same as those set in **Set Units**.

The factory default setting is zero for these fields.

Alarm	Description
Alarm Trip Point High	Value above which an alarm occurs.
Alarm Trip Point Low	Value below which an alarm occurs.
Alarm Hysteresis	The amount by which the value must recover to clear an alarm.
Alarm Settling Time	The amount of time that the value must exceed the trip point before an alarm is triggered (in msec).

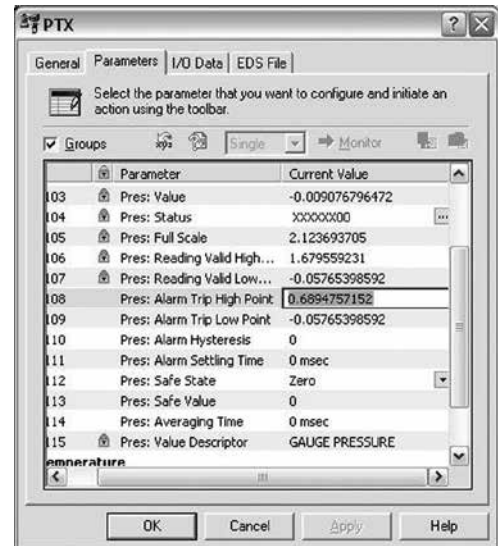

Fig. 10 Set Alarms

Set Averaging Time

The PTX allows the averaging time of the measured value to be set. This allows the user to implement a type of low pass filtering on the measured data, removing transient measurements from the reported values. This parameter is entered as the amount of time over which the measurements will be averaged in milliseconds (msec). The factory default is 0 msec.

Alarm Enable

The alarm enable sets whether the alarms are activated.

Maintenance Dates

The last and next maintenance date can be set by the user. The factory set default for both fields is the date of manufacture.

Parameter Name	Description
Last Maintenance Date	Documents the date maintenance was performed.
Next Maintenance Date	Documents the next date maintenance will be performed. This would be determined by the system calibration schedule.

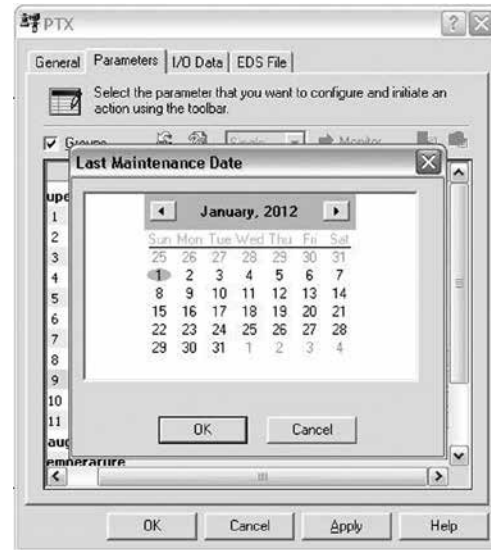

Fig. 11 Maintenance Dates

Operation

Zero Compensation

To achieve the specified pressure accuracy from the PTX, under all conditions, the following zero compensation procedure must be performed. Zero compensation for the PTX is essentially equivalent to the tare function on a weight scale.

1. Apply 0 psig (i.e. ambient atmospheric pressure) to the PTX.
2. Allow the PTX to stabilize to the temperature and atmospheric pressure of the environment in which it is installed.
3. With 0 psig applied to the PTX, retrieve a series of measurements (10 or more) from the PTX and average them together. This average is call the zero compensation offset.
4. Zero compensate subsequent PTX measurements by subtracting the zero compensation offset from them.

Zero compensated PTX measurements are guaranteed to be less than 1 % of full scale away from the actual pressure applied to the PTX. The span of the PTX never needs adjusted or calibrated.

NOTE: Excessive over pressure conditions may require the zero compensation procedure to be repeated to maintain the PTX's high accuracy.

Poll Request

Send a poll request to the configured PTX's MAC ID in order to receive data. The PTX will return a status message in the format set for Message Format, Units, and Alarms in **Setup**.

For example:

If the value has been set up to be returned as an integer, a pressure value of 100 psig (6.8 bar) would be converted to a hexadecimal as 0x0064, then transmitted by the PTX to the network as 0x6400. The last byte (0x00) represents the most significant byte while the lower byte encodes the least significant byte.

If the value has been set up to be returned as a real number, a pressure value of 100.00 psig (6.8 bar) would be converted to a IEEE-754 compliant real value of 0x42C80000, then transmitted by the PTX to the network as 0x0000C842.

Notice that the integer data format is shorter, which will result in less network traffic. However, the real number format contains decimal values, which results in higher measurement resolution.

The status byte will return the status of the alarms in the following format.

Status Byte							
Bit 7	Bit 6	Bit 5	Bit 4	Bit 3	Bit 2	Bit 1	Bit 0
0	0	0	PUR	POR	TUR	TOR	Power
1 = true; 0 = false							

Bits 1 through 4 refer to alarms set to show true when the measured pressure or temperature value exceed preset levels:

Bit 4: PUR—Pressure Under Alarm Trip Point

Bit 3: POR—Pressure Over Alarm Trip Point

Bit 2: TUR—Temperature Under Alarm Trip Point

Bit 1: TOR—Temperature Over Alarm Trip Point

The alarms on the PTX can be reset by sending a Reset Byte to the device. The format should be as follows:

Reset Byte							
Bit 7	Bit 6	Bit 5	Bit 4	Bit 3	Bit 2	Bit 1	Bit 0
0	0	0	0	0	0	0	1

Maintenance

Additional assembly hardware for the MPC surface mount is available. Refer to *Modular Platform Components (MPC)*, MS-02-185, for ordering information.

There are no field-maintainable parts within the PTX. Contact your authorized Swagelok representative for assistance.

Troubleshooting

Problem	Cause	Remedy
Module (MOD) Light		
Off	No power applied to the device.	Connect power.
Green	Normal operation.	No action needed.
Flashing Green	Device needs to be configured.	Configure device.
Red	Device has an unrecoverable fault.	Cycle power to device. If device fails to recover, contact your authorized Swagelok representative.
Flashing Red	Device has invalid configuration.	Check configuration setup.
Network (NET) Light		
Off	The device has no power or the channel is disabled for communication due to bus off condition, loss of network power, or has been intentionally disabled.	Power-up the DeviceNet scanner, provide network power to channel, and make sure channel is enabled in both the scanner configuration table and module command word.
Green	Normal operation.	No action needed.
Flashing Green	The channel is enabled but no communication is occurring. The two-digit numeric display for the channel on the DeviceNet scanner indicates an error code that provides more information about the condition of the channel.	Configure scan list table for channel to add device.
Red	The communication channel has failed. The two-digit numeric display for the channel on the DeviceNet scanner indicates an error code that provides more information about the condition of the channel. This may indicate a defective DeviceNet scanner.	Reset DeviceNet scanner. If failures continue, replace DeviceNet scanner.
Flashing Red	At least one of the devices in the DeviceNet scanner's scan list table has failed to communicate with the DeviceNet scanner. The network has faulted. The two-digit numeric display for the channel on the DeviceNet scanner indicates an error code that provides more information about the condition of the channel.	Examine the failed device and examine the scan list table for accuracy.
General		
System displays pressure when process media supply has been turned off.	Measurement is within of tolerance band.	The PTX measures pressure within a tolerance of $\pm 1\%$ of the full scale range of the device. A reading of 0.5 psig (0.03 bar) for a 50 psig (3.4 bar) PTX is normal even when system pressure is at zero.
	Ambient temperature is outside of specification.	The pressure measurement will not be thermally compensated when the ambient temperature is outside the specified range.
	Process media is trapped within the system.	Ensure the system has been properly vented.
	The sensor element has been damaged.	Replace the PTX.
The PTX goes offline periodically.	The M12 connector is loose.	Ensure that the M12 connector has proper thread engagement and is firmly attached.

Contact your authorized Swagelok representative for additional assistance.

Glossary

Term	Definition
CAN	Controller Area Network, a message based communication protocol
DeviceNet Scanner	Device that provides the bridge between the DeviceNet network and the PLC
EDS	Electronic data sheet, a file used by node commissioning tools to interpret parameters on the device
Entity Parameters	Values used to determine the suitability of the device for use in hazardous environments
LED	Light Emitting Diode
MAC ID	Media access controller identifier
MOD LED	Module LED, a light that provides feedback on the status of the module
NET LED	Network LED, a light that provides feedback on the status of the PTX network connection
PLC	Programmable Logic Controller